



Your Partner In Lift Solutions.

Catálogo Técnico.



Catálogo Técnico Raloe



01

▶ **Desarrollo de Producto**

1.1 Symbio	—	03
1.2 Symbio grandes cargas	—	09
1.3 Optimus	—	11
1.4 Genesis	—	17
1.5 Hydronic	—	21
1.6 Soluciones Regenerativas	—	23

02

▶ **Acabados**

2.1 Modelos de cabina	—	25
2.2 Cabinas panorámicas	—	31
2.3 Acabados de cabinas	—	35
2.4 Puertas	—	42
2.5 Botoneras y Displays	—	45
2.6 Estructuras	—	49





1.1

Symbio es el ascensor eléctrico con o sin cuarto de máquinas capaz de adaptarse a cualquier necesidad de hueco, de foso o de huida.

Amplio abanico de cargas.

► Aplicaciones

Edificio Residencial
Centro Comercial
Obra Nueva
Hoteles
Hospitales
Oficinas
Montacamillas
Edificios de Gran Altura
Alto tráfico

Ventajas

Tanto para obra nueva como para hueco existente con fosos y huidas reducidas (EN 81.21).

Versatilidad:

No es necesario el cuarto de máquinas, proporcionando mayor libertad de diseño del edificio. A pesar de que es el ascensor para huecos de obra nueva por excelencia, es adaptable a infinidad de huecos. Huecos especiales.

Flexibilidad/Adaptabilidad:

Customizado a cada cliente. Amplio rango de cargas, tamaños y velocidades. Robusto, resistente y fiable. Posibilidad de ubicar la maniobra tanto en el marco de la puerta (ancho 120mm) como en el rellano. Tensión de línea trifásica o monofásica.

Confort:

Gracias a la configuración con chasis centrados y suspensión 2:1, se garantiza un nivel de confort máximo durante el desplazamiento con una mínima contaminación acústica.

Gran durabilidad:

Mantenimiento reducido. El aparato tiene una larga vida y las reparaciones son prácticamente nulas.

Fácil instalación:

Diseño maduro, plug and play. Bancada autoportante soportada sobre las propias guías.

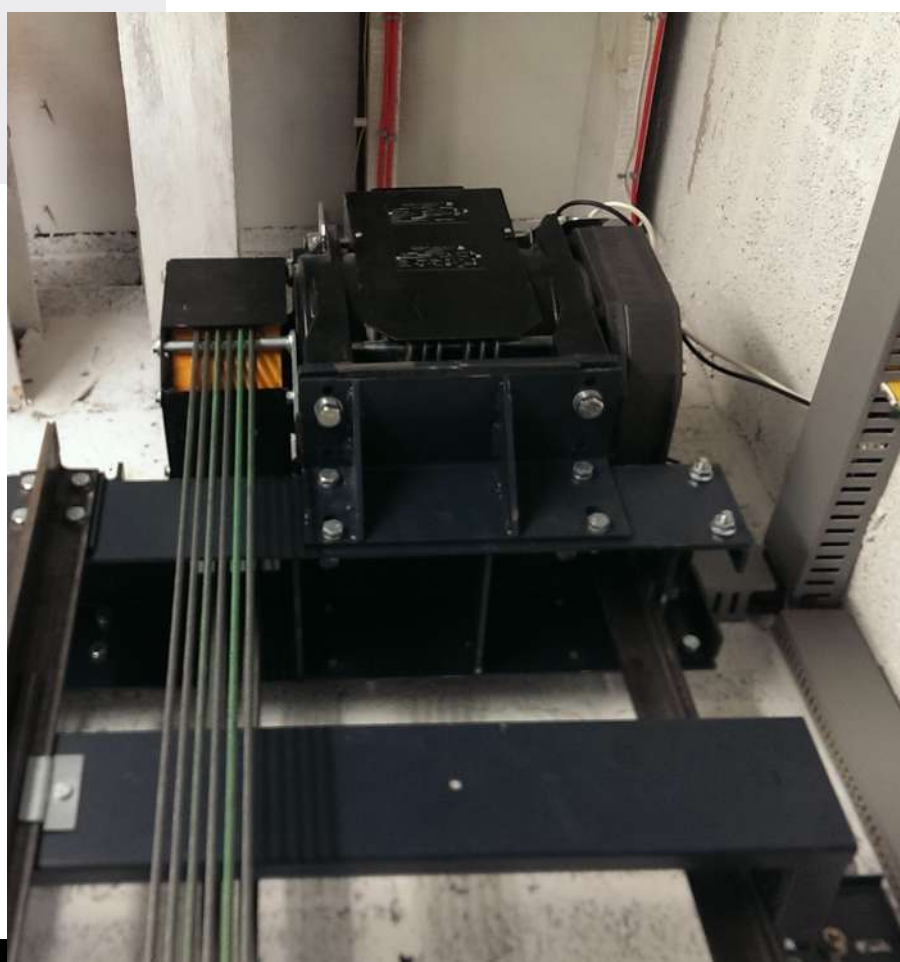

Características Técnicas

Carga Nominal (Kg)	300 - 1.600
Velocidad Nominal (m/s)	0,5 - 3,0
Cuarto de Máquinas	CCM / SCM
Recorrido (m)	Hasta 100
Suspensión	2:1
Diámetro del Cable (mm)	6,5 - 8,0
Sistema de Guiado	Deslizaderas amortiguadas alto confort.

Q (kg)	Fosos mínimos (mm)		Huidas mínimas (mm) ⁽¹⁾	
	Foso mín.	Huida necesaria	Huida mín.	Foso necesario
450	340	3.370	2.985	615
630	340	3.370	2.985	660
1.000⁽²⁾	340	3.370	3.000	660
1.000⁽³⁾	345	3.415	3.090	680
1.600	450	3.540	3.330	705

Embarques 0° - 180°

Tipo de Puerta Automática - Semiautomática

Ascensor Panorámico Sí

Ascensor Intemperie Sí

(1) Datos para instalaciones a 1 m/s. Huidas calculadas con una altura interior útil de cabina de 2.005 mm.

(2) Fosos y huidas mínimas para P+Q hasta 1.933 Kg.

(3) Fosos y huidas mínimas para P+Q hasta 2.750 Kg.

Soluciones especiales

Posibilidad de configuraciones especiales para huecos irregulares.

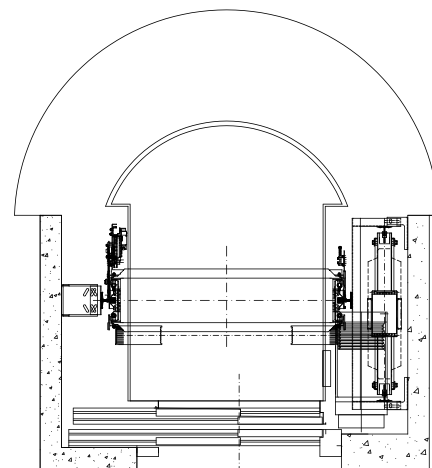

Altas Velocidades V- Hasta 3m/s

Para velocidades \geq a 1,6 m/s, rodaderas triples. Máximo confort.

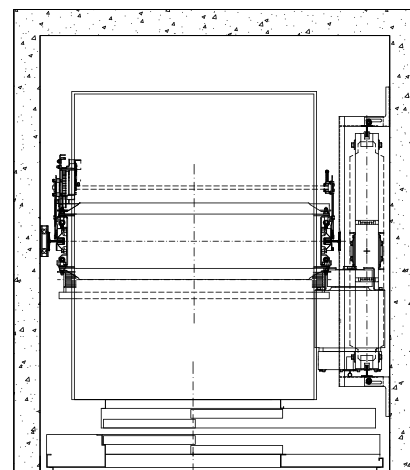
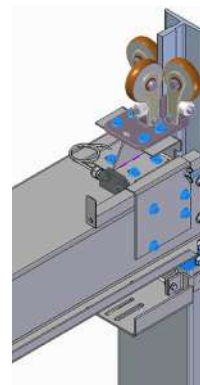

Características Técnicas Symbio HR

Carga Nominal (Kg)	300 - 1.600
Velocidad Nominal (m/s)	0,5 - 1,0
Cuarto de Máquinas	CCM / SCM
Recorrido (m)	Hasta 50
Suspensión	2:1
Diámetro del Cable (mm)	6,5 - 8,0
Sistema de Guiado	Deslizaderas amortiguadas alto confort.

Q (Kg)	Huidas Mínimas (mm) ⁽²⁾	
	Huida necesaria	Foso mín.
450	2.430	615
630	2.430	660
1.000⁽³⁾	2.430	660
1.000⁽⁴⁾	2.430	680
1.600	2.760	705

Embarques	0° - 180°
Tipo de Puerta	Automática - Semiautomática
Ascensor Panorámico	Sí
Ascensor Intemperie	Sí

- (1) Huida mínima alcanzable para cabinas EN81.70 Tipo 2 y ancho de hueco 1.600 mm.
 (2) Datos para instalaciones a 1 m/s. Huidas calculadas con una altura interior útil de 2.005 mm.
 (3) Fosos y huidas mínimas para P+Q hasta 1.933 Kg.
 (4) Fosos y huidas mínimas para P+Q hasta 2.750 Kg.

Soluciones a medida

Symbio HR
Huida 2.430 mm.⁽¹⁾

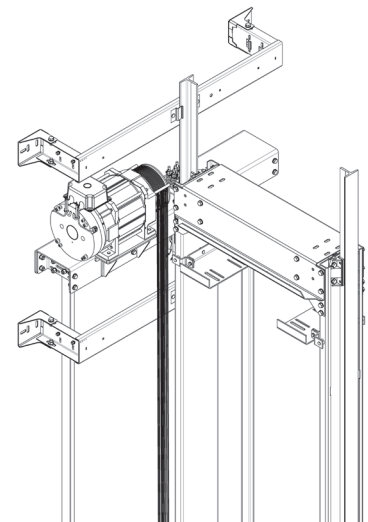

Características Técnicas Symbio PF

Carga Nominal (Kg)	300 – 600 ⁽¹⁾
Velocidad Nominal (m/s)	0,5 - 1,0
Cuarto de Máquinas	CCM / SCM
Recorrido (m)	Hasta 50
Suspensión	2:1
Diámetro del Cable (mm)	6,5
Sistema de Guiado	Deslizaderas amortiguadas alto confort.

Symbio PF
Fondo Hueco 720 mm.

Velocidad máxima: 1 m/s.
Armario maniobra en rellano.

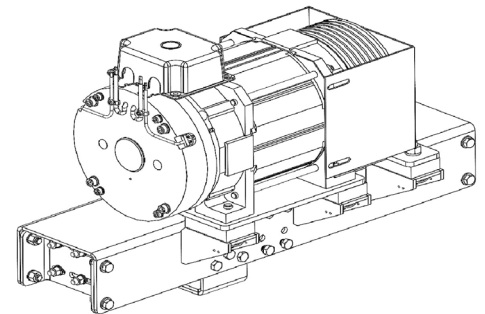

Q (Kg)	Fosos mínimos (mm)		Huidas Mínimas (mm) ⁽²⁾	
	Foso mín.	Huida necesaria	Huida mín.	Foso necesario.
450	340	3.370	2.985	615
630	340	3.370	2.985	660

Embarques 0° – 180°

Tipo de Puerta Automática - Semiautomática

(1) Para el resto de cargas, consultad.

(2) Datos para instalaciones a 1 m/s. Huidas calculadas con una altura interior útil de cabina de 2.005 mm.

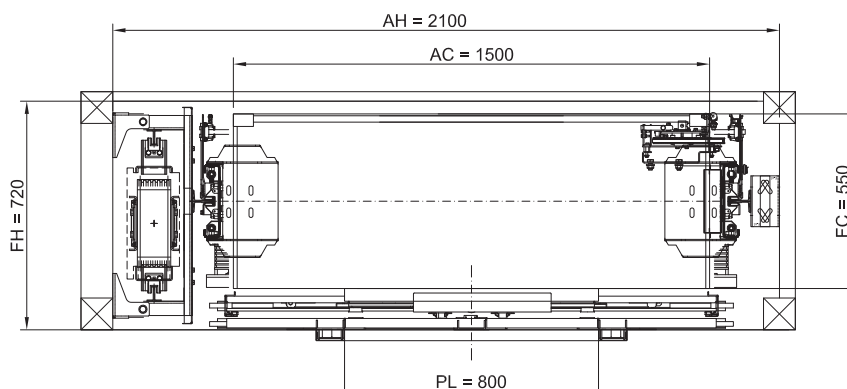

Características Técnicas Symbio G

Carga Nominal (Kg)	1.800-3.000
Velocidad Nominal (m/s)	0,5 - 1,0
Cuarto de Máquinas	CCM / SCM
Recorrido (m)	Hasta 70
Suspensión	2:1
Diámetro del Cable (mm)	8 - 10
Sistema de Guiado	Deslizaderas alto confort. Para velocidades $\geq 1,6$ m/s, siempre rodaderas triples.
Fosos mínimos (mm)	780
Huidas mínimas (mm)	3.485
Embarques	0° - 180°
Tipo de Puerta	Automática
Ascensor Panorámico	Sí
Ascensor Intemperie	Sí

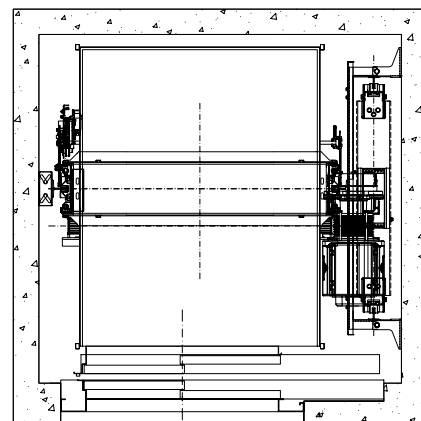



1.2

Ascensor Symbio sin cuarto de máquinas para grandes cargas con suspensión 4:1.

► Aplicaciones

Centro Comercial
Hoteles
Hospitales
Oficinas
Grandes cargas
Industria

Características Técnicas Symbio GC

Carga Nominal (Kg) 3.100 - 7.000

Velocidad Nominal (m/s) 0,5 - 1,0

Cuarto de Máquinas CCM / SCM

Recorrido (m) Hasta 70

Suspensión 4:1

Diámetro del Cable (mm) 10

Carga (Kg)	Altura int. cabina (mm)	Foso máximo (mm) Aproximado	Huida mínima (mm) Aproximado
7.000	3.000	2.000	5.500
5.000	2.500	1.600	4.500
4.000	2.500	1.600	4.500

Embarques 0° - 180°

Tipo de Puerta Automática

Ascensor Panorámico Sí

Ascensor Intemperie Sí

Ventajas

Confort:

Tracción 4:1 con poleas por debajo del chasis, proporcionando una excelente estabilidad y gran confort.

Fácil instalación:

Bancada autoportante y viga de poleas preparada para adaptarse al hueco.

Adaptabilidad:

Posibilidad de antiderivas para cargas puntuales elevadas.

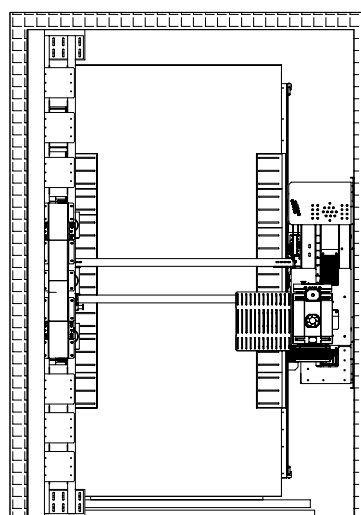
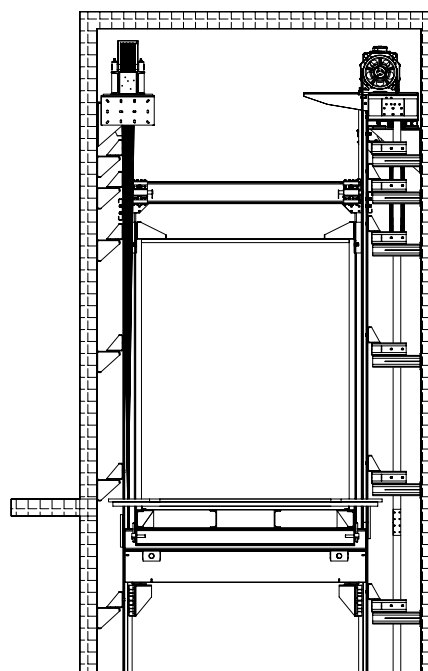



1.3

Optimus es el ascensor eléctrico con o sin cuarto de máquinas que más optimiza el hueco del mercado.

► Aplicaciones

Residenciales
Modernizaciones
Huecos Existentes
Rehabilitaciones
Huecos mínimos

Ventajas

Flexibilidad:

Permite configuración de simple, doble y triple embarque. Ideal para soluciones a 90°.

Monofásico:

Funciona en cualquier enchufe monofásico 220V.

Fácil instalación:

Bancada de fácil montaje. Autoportante.

Adaptabilidad:

Posibilidad de diseño con norma EN 81.21 para foso y huida reducida. Customizado a cada cliente.

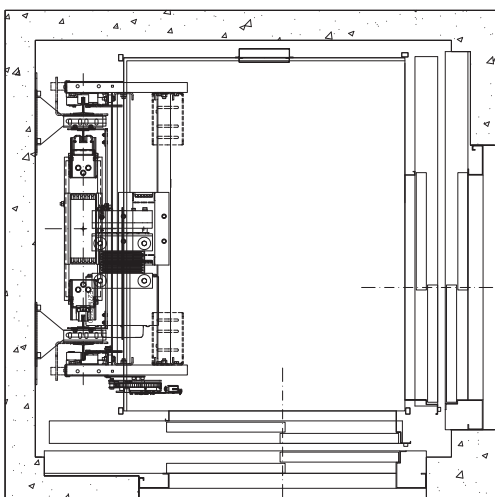
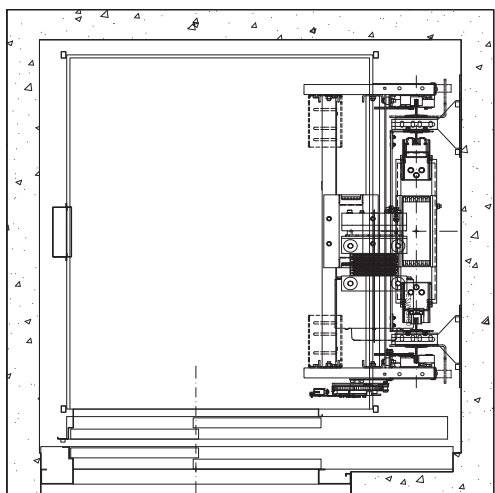

Características Técnicas

Carga Nominal (Kg) 180 - 1.250

Velocidad Nominal (m/s) 0,5 - 1,0

Cuarto de Máquinas CCM / SCM

Embarques 0° - 90° - 180° - 270°

Suspensión 1:1 2:1

Diámetro del Cable (mm) 6,5 - 8,0

Sistema de Guiado Pivotantes o rodaderas en el lado de la caja de cuñas para garantizar funcionamiento.

Q (Kg)	Fosos mínimos		Huidas mínimas ⁽¹⁾	
	Foso mín.	Huida necesaria	Huida mín.	Foso necesario.
450	300	3.400	3.225	640
630	300	3.400	3.225	640
1.250	470	3.050	3.050	470

Recorrido (m) Hasta 50

Tipo de Puerta Automática - Semiautomática

Cota técnica (mm) 270

Ascensor Panorámico Sí

Ascensor Intemperie Sí

Tensión Alimentación Monofásica / Trifásica

(1) Datos para instalaciones a 1 m/s. Huidas calculadas con una altura interior útil de cabina de 2.005 mm

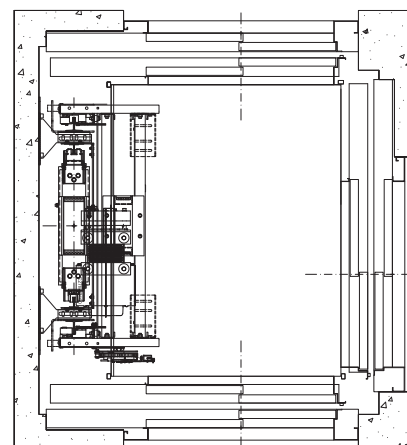

Características Técnicas Optimus FHR

Carga Nominal (Kg)	180 - 630
Velocidad Nominal (m/s)	0,5 - 1,0
Cuarto de Máquinas	CCM / SCM
Embarques	0° - 90° - 180° - 270°
Suspensión	2:1
Diámetro del Cable (mm)	6,5
Sistema de Guiado	Pivotantes o rodaderas en el lado de la caja de cuñas para garantizar funcionamiento.
Fosos mínimos (mm)	300
Huidas mínimas (mm) ⁽¹⁾	2.750
Recorrido (m)	Hasta 50
Tipo de Puerta	Automática - Semiautomática
Cota técnica (mm)	435
Ascensor Panorámico	Sí
Ascensor Intemperie	Sí
Tensión Alimentación	Monofásica / Trifásica

(1) Datos para instalaciones a 1 m/s. Huidas calculadas con una altura interior útil de cabina de 2.005 mm

Soluciones a medida

Cota Técnica 435 mm.

Q máx: 630 Kg (Qt máx: 1550 Kg)
Foso mínimo: 300 mm.
Huida mínima: 2400 mm.
Cota técnica: 435 mm.

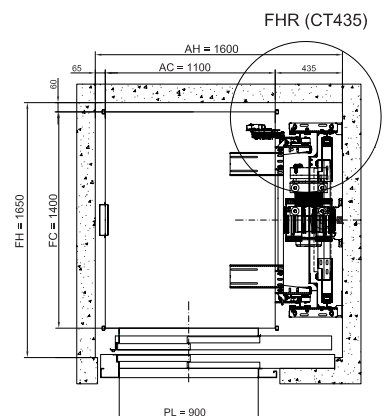

FHR-3D

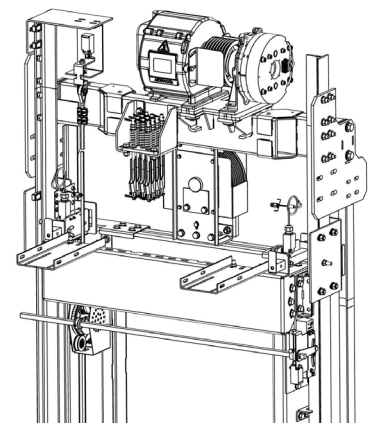

Características Técnicas Optimus GP

Carga Nominal (Kg)	180 - 375
Velocidad Nominal (m/s)	0,5 - 1,0
Cuarto de Máquinas	CCM / SCM
Embarques	0° - 90° - 180° - 270°
Suspensión	2:1
Diámetro del Cable (mm)	6,5
Sistema de Guiado	Rozaderas
Fosos mínimos (mm)	350
Huidas Mínimas (mm) ⁽¹⁾	Si HR 2.750 mm/ Si normal 3.200 mm
Recorrido (m)	Hasta 50
Tipo de Puerta	Automática - Semiautomática
Cota técnica (mm)	410
Ascensor Panorámico	Sí
Ascensor Intemperie	Sí
Tensión Alimentación	Monofásica / Trifásica

(1) Datos para instalaciones a 1 m/s. Huidas calculadas con una altura interior útil de cabina de 2.005 mm

Optimus GP
Ancho hueco 650 mm.

Q máxima: 375 kg (Qt máx: 1165 kg.)
Foso mínimo: 350 mm.
Huida mínima: 3.200 mm.
Cota técnica: 410 mm.
Armario maniobra en rellano.

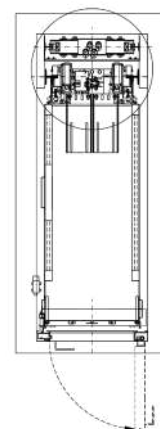
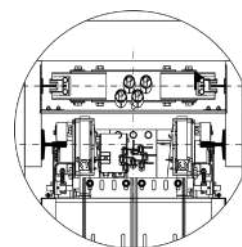
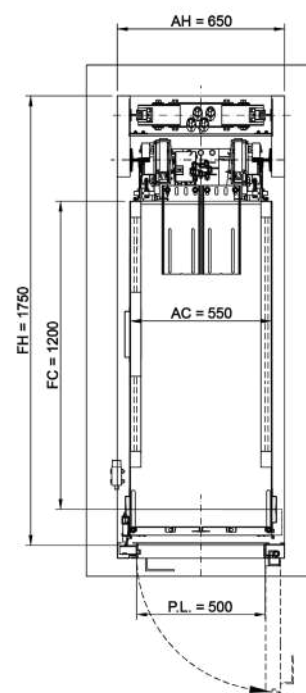

Caract. Técnicas Optimus FHR cota reducida

Carga Nominal (Kg)	180 - 630
Velocidad Nominal (m/s)	0,5 - 1,0
Cuarto de Máquinas	CCM / SCM
Embarques	0° - 90° - 180° - 270°
Suspensión	2:1
Diámetro del Cable (mm)	6,5
Sistema de Guiado	Rozaderas
Fosos mínimos (mm)	350
Huidas Mínimas (mm) ⁽¹⁾	2.460
Recorrido (m)	Hasta 50
Tipo de Puerta	Automática - Semiautomática
Cota técnica (mm)	350
Ascensor Panorámico	Sí
Ascensor Intemperie	Sí
Tensión Alimentación	Monofásica / Trifásica

Optimus 81.70
Emb 90°

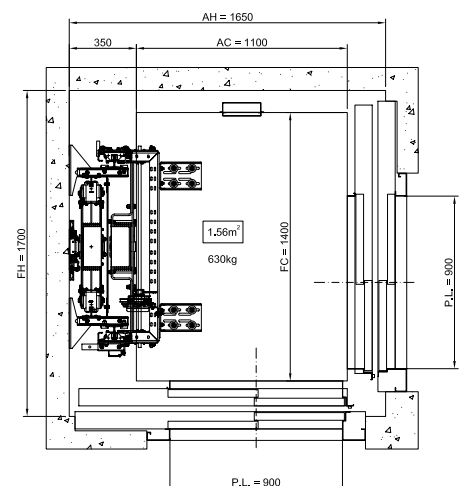

(1) Datos para instalaciones a 1 m/s. Huidas calculadas con una altura interior útil de cabina de 2.005 mm



1.4

Genesis es el ascensor eléctrico convencional con cuarto de máquinas, disponible con Reductor o con Gearless.

► Aplicaciones

Rehabilitaciones
Edificios de Gran Altura
Alto Tráfico
Modernizaciones

Características Técnicas Genesis

Carga Nominal (Kg) 300 - 5.000

Velocidad Nominal (m/s) 0,63 - 3,0

Cuarto de Máquinas CCM

Recorrido (m) Hasta 100

Suspensión 1:1 - 1:2 - 4:1

Diámetro del Cable (mm) 6,5 - 8 - 10 - 12

Sistema de Guiado Deslizadera >1,6 Rollers

Q (kg)	Fosos mínimos (mm)		Huidas mínimas ⁽¹⁾ (mm)	
	Foso mín.	Huida mín.	Foso mín.	Huida mín.
450	360	3.170	685	3.040
600	360	3.170	715	3.135
1.000	730	3.315	730	3.315
1.350	730	3.315	730	3.315

Embarques 0° - 90° - 180° - 270°

Tipo de Puerta Automática-Semiautomática

Máquinas Fabricante Reductores - Gearless

Ascensor Panorámico Sí

Ascensor Intemperie Sí

(1) Datos para instalaciones a 1 m/s. Huidas calculadas con una altura interior útil de cabina de 2.105 mm

Soluciones a medida

Ventajas

Adaptabilidad:

Facilidad de adaptarse a los huecos existentes.

Versatilidad:

Grandes cargas y largos recorridos.

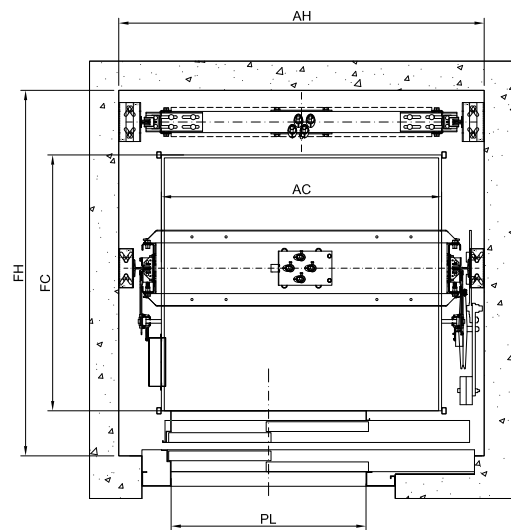

Guías Esquinadas

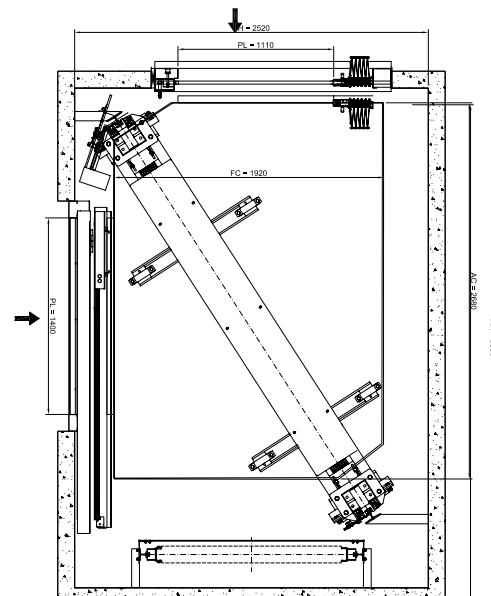



1.5

Hydronic es el ascensor hidráulico ideal para edificios existentes, capaz de adaptarse a cualquier tipo de hueco.

► Aplicaciones

Residenciales
Modernizaciones
Huecos Existentes
Rehabilitaciones
Huecos mínimos

Ventajas

Versatilidad:

Adaptamos cada ascensor a cada hueco diferente optimizando espacios.

Fosos y Huidas reducidos:

En edificio existente, adaptamos nuestros ascensores en cumplimiento de la normativa para fosos y huidas reducidos (EN 81.21).

Confort:

Excelente nivel de confort que se iguala al ascensor eléctrico utilizando válvulas electrónicas.

Adaptabilidad:

Fácil regulación y mantenimiento.

Seguridad:

Maniobra de emergencia automática siempre activa en bajada, incluso con fallo del motor.

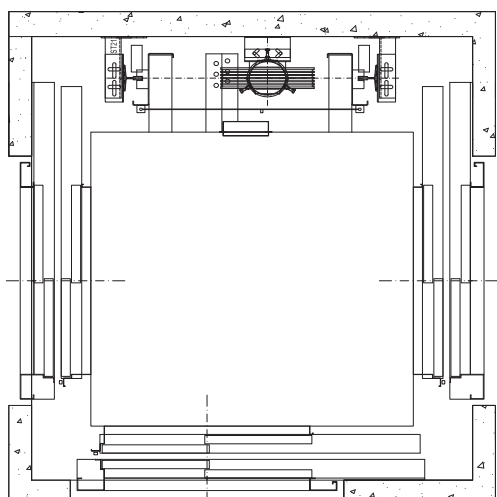
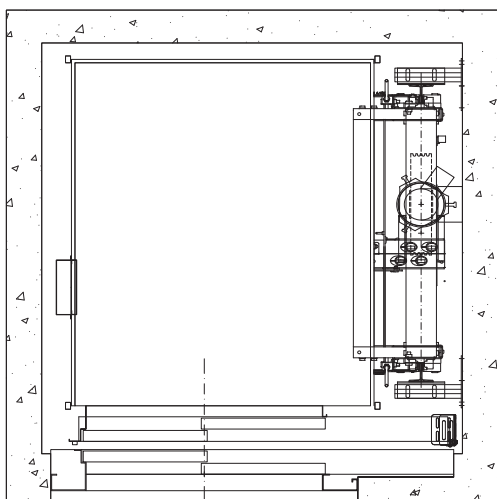

Características Técnicas

Carga Nominal (Kg)	100 - 1.800
Velocidad Nominal (m/s)	0,2 - 0,63 Opción hasta 1
Cuarto de Máquinas	CCM / Central en armario / Central foso
Embarques	0° - 90° - 180° - 270°
Suspensión	1:1 2:1
Diámetro del Cable (mm)	6,5 - 8 - 9 - 10 - 12
Sistema de Guiado	Pivotantes o rodaderas en el lado de la caja de cuñas para garantizar funcionamiento.

Fosos y huidas mínimas (mm)		
Q (Kg)	Foso mín.	Huida mínima
320	255	2.720
630	265	2.660
1.000	350	2.860
1.250	740	2.860
1.600	740	2.860

Recorrido (m) Hasta 25

Tipo de Puerta Automática - Semiautomática

Equipos hidráulicos GMV - MORIS - BUCHER

Ascensor Panorámico Sí

Ascensor Intemperie Sí

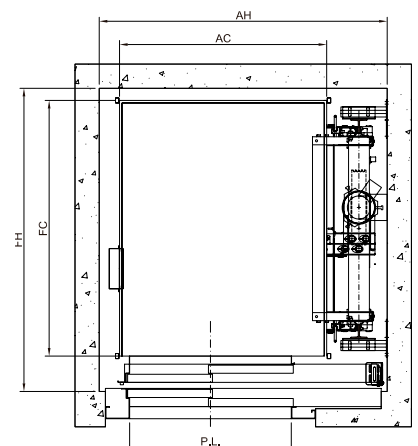

Panorámicos

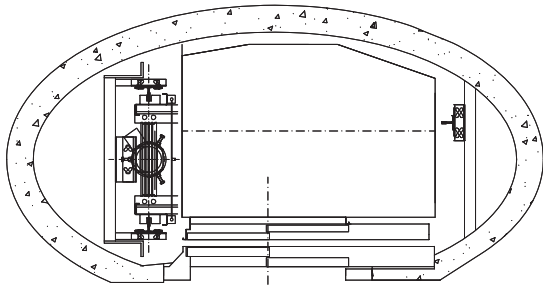

Huecos irregulares

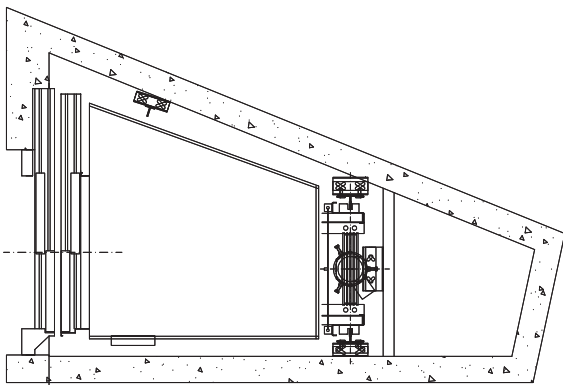

Pistones enterrados

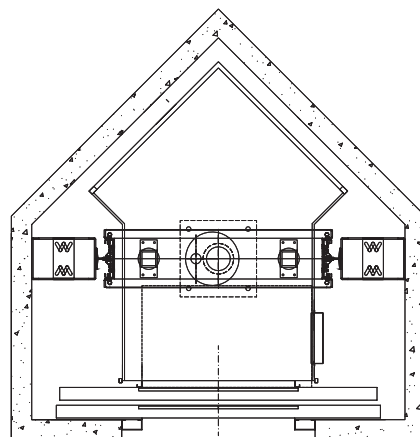
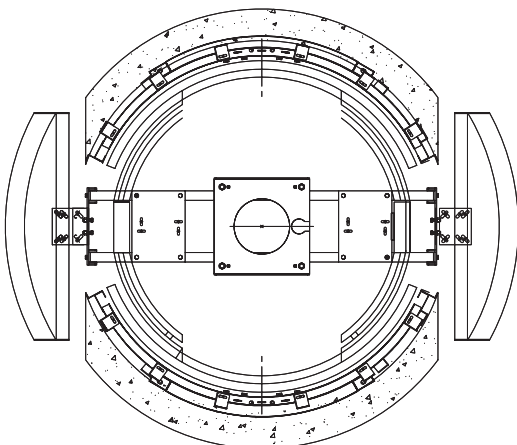

ERS 2G – Energy Recovery System

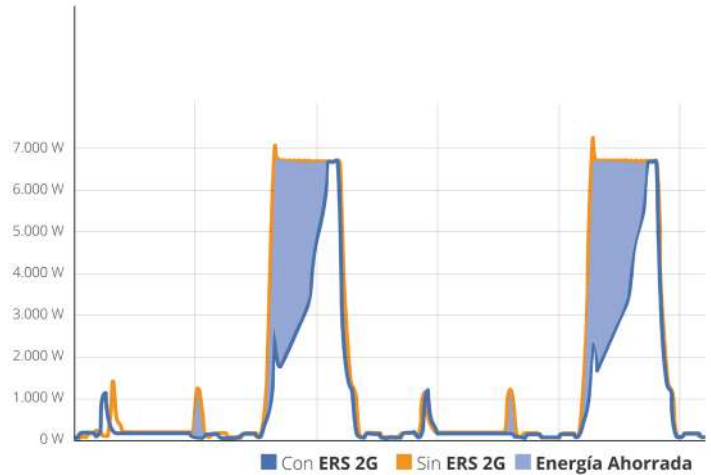

- ▶ Revoluciona el consumo del ascensor. Solución regenerativa con almacenamiento de energía. Recupera la energía generada por el ascensor y la devuelve al mismo ascensor reduciendo el consumo de tracción en hasta un 70%. Enchufar y listo.

P2S – plug to single-phase

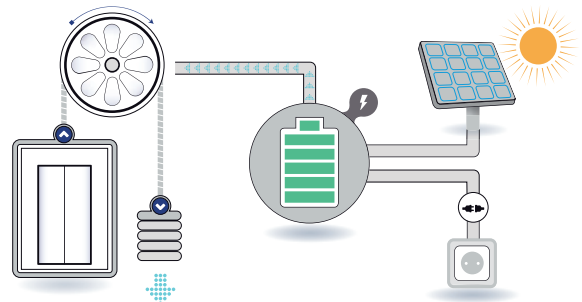

- ▶ Alimenta un ascensor trifásico desde cualquier acometida monofásica con 500W máximos de consumo. Permite el uso del ascensor en caso de corte de luz y permite transformar el ascensor en uno solar con solo 2 paneles.



Your Partner
In Lift Solutions.





2.1

Modelos de cabina

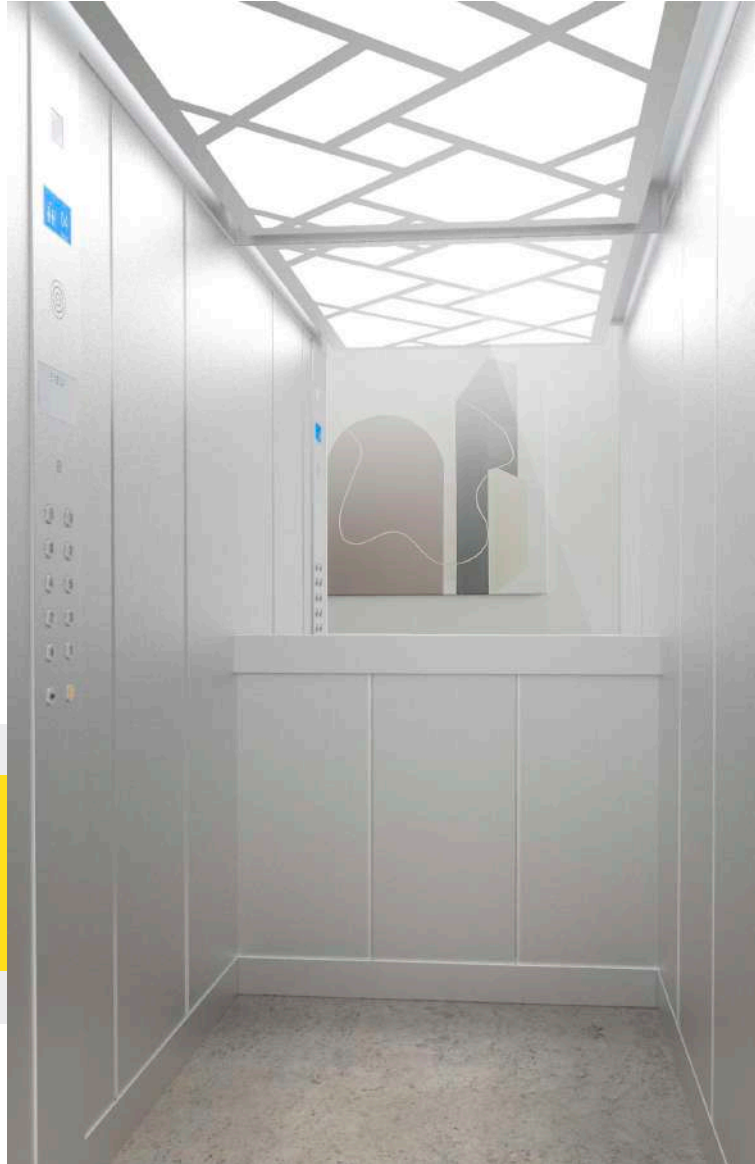

101

Paños

Unión

Suelo

Acero Inox. Checks

Lama sin separación

Granito Natural Warwick



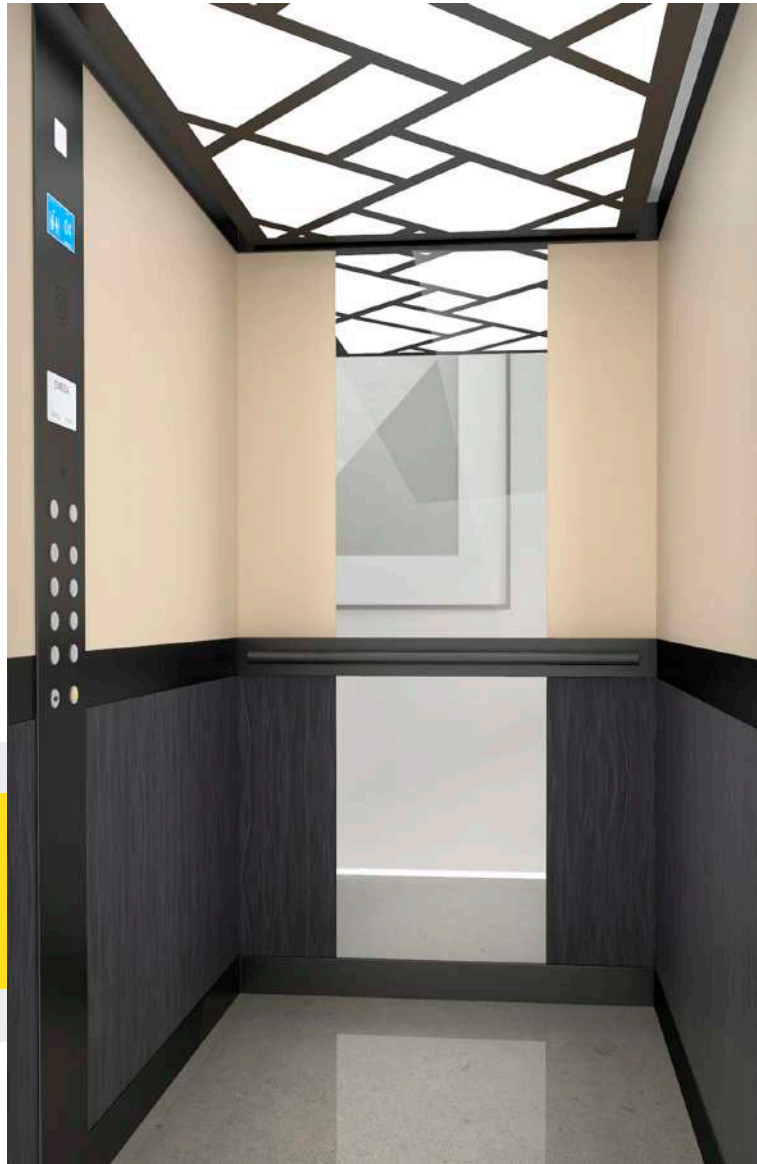

L03

Paños

Unión

Suelo

F6307 Burnt Strand

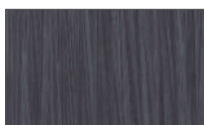

F2833 Arena Pétreca

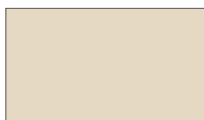

Laminado

Paño liso

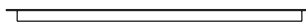

Piedra artificial Royal Reef



* M03 también disponible en Melamina



2.1

Modelos de cabina

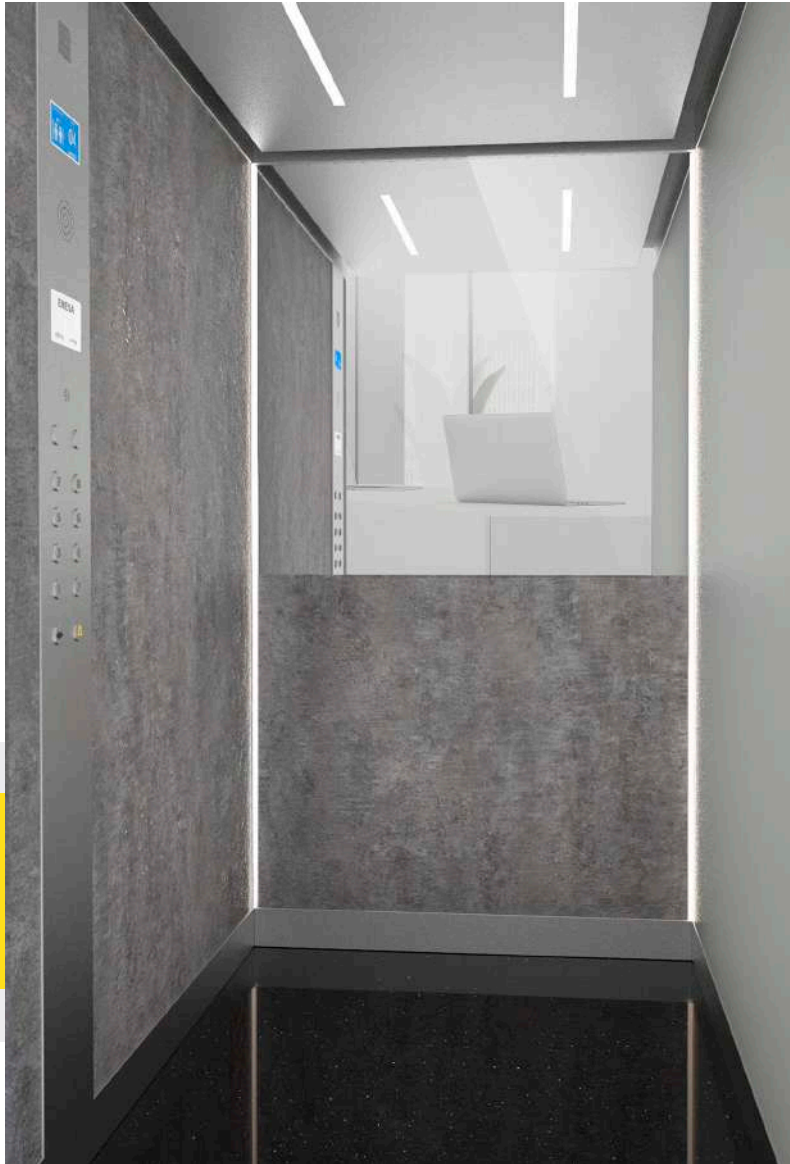

L04

Paños

F7327 Gris Popular



F8830 Elemental Concrete



Laminado

Unión

Paño liso



Suelo

Negro Stellar



Iluminación paño

Pareja tiras LED verticales



S01

Paños

Skinplate Acero Inox



Unión

Lama sin separación



Suelo

Antideslizante negro





2.1 Modelos de cabina



CH01

Paños

Marfil Claro RAL 1015

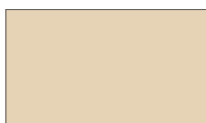

Chapa pintada

Unión

Lama sin separación



Suelo

Rosa Porriño





Quartz

Paños

Rojo Terracota RAL 8815

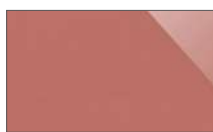

Vidrio lacado

Unión

Paño liso



Suelo

Negro Inteso





Matrix

Cabinas rectangulares con diferentes variaciones en la disposición del cristal.

Modelos M100, M200, M300: Unión entre cristales enmarcado con perfiles.

Modelos M100d, M200d, M300d: Unión entre cristales sin perfiles.

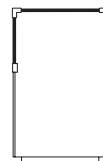

M100

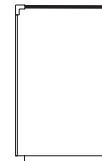

M300



M100d

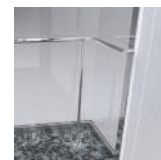

M200

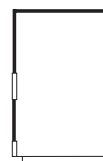

M200d

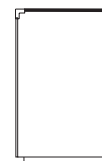

M300d



Disponemos de multitud de formas para las cabinas panorámicas con uno o más paños de cristal.



Vector

Frontal de cabina poligonal o curvo, con o sin uniones entre cristales.

Modelos V100, V300: Unión entre cristales enmarcado con perfiles.

Modelos V100d, M300d: Unión entre cristales sin perfiles.



V100



V100d

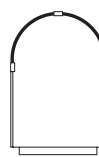

V300



V300d



Consultar compatibilidad modelo/carga.



Century

Cabinas acristaladas completamente circulares

Modelos C100: Unión entre cristales enmarcado con perfiles.

Modelos C200: Unión entre cristales sin perfiles.

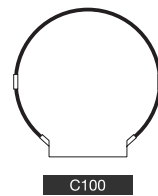

C100

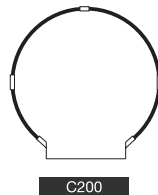

C200

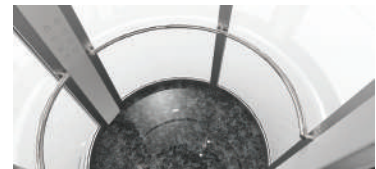



2.3 Acabados de cabina

Paños

Skinplates



Blanco



Simil Inox.

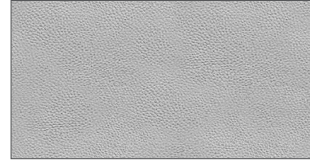

Gris



Acero Inox.

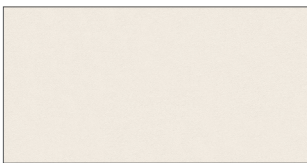

Crema

Chapa pintada



Blanco RAL 9016



Beige RAL 1019



Negro RAL 9005



Marfil Claro RAL 1015



Gris metalizado RAL 9006



Gris claro perlado RAL 9022

2

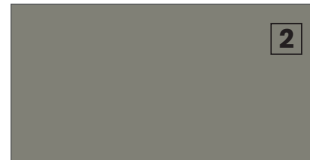

Gris Hormigón RAL 7023

2



Violeta Pastel RAL 4009

2

2 Tarifa Tipo 2

*Cualquier otro RAL disponible bajo pedido

Aceros inoxidables

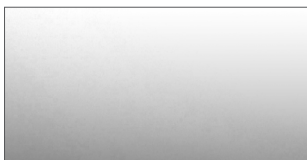

Satinado

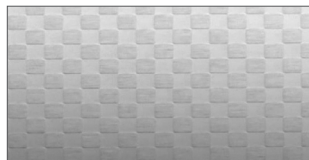

Checks

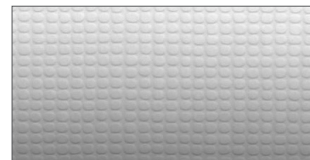

Canvas



Cuero

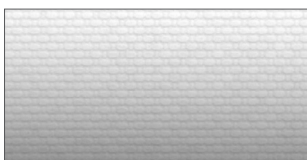

Linen



Pulido

Disponibles cualquier otro acabado de:





Paños

Vidrio lacado



Gris metal RAL 9006



Marrón Claro RAL 1236



Verde RAL 8615



Aluminio RAL 9007

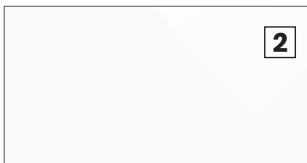

Blanco puro RAL 9003



Negro Estelar RAL 0337



B. Perla RAL 1013 (mate o brillo)



Bronce

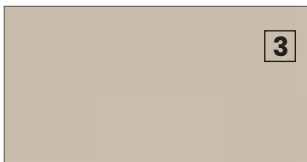

Marrón Claro RAL 1236 (Mate)



Rojo Terracota RAL 8815



Verde Pistacho RAL 1164

2 Tarifa Tipo 2

3 Tarifa Tipo 3

Vidrio lacado bajo pedido



RAL 1586



RAL 8017

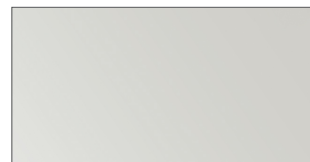

PLATA



RAL 5002



RAL 2001



RAL 9005

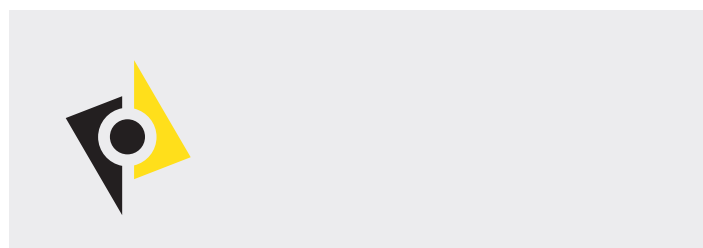



2.3 Acabados de cabina

Laminados

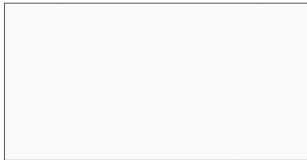

F2274 Blanco Francia



F1139 Cerezo



F7884 Azul China



F7837 Grafito

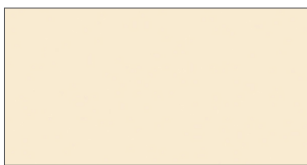

F2273 Seringa



F1062 Roble

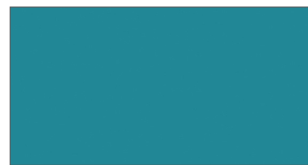

F2478 Turquesa



F8833 Elemental Graphite

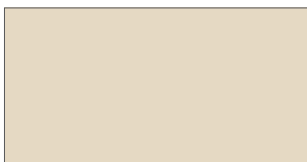

F2833 Arena pétrea



F5873 SET Ventura Oak



F1997 Oceano



F8832 Elemental Corten



F8841 White Ash

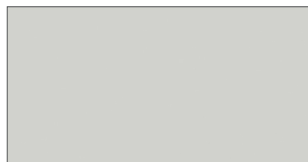

F7927 Gris Popular



F8849 Natural Teak

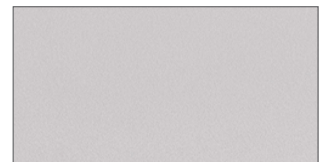

F0193 Xenon



F0190 Haya finlandesa



F8830 Elemental Concrete



F8848 Blackened Legno

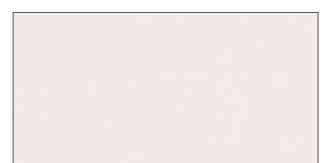

F7923 Surf



F3091 Blanco Polar Brillo



F6307 Burnt Strand

3 Tarifa Tipo 3

* Resto de formicas disponibles en
<https://www.formica.com/es-es>

Los colores mostrados pueden variar respecto a los reales, en función de la configuración del monitor o de las condiciones de impresión.



Paños

Melamina

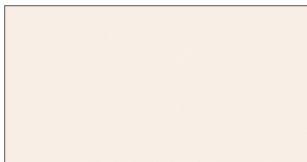

Crema

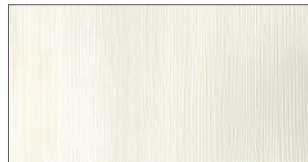

Pino Cervino

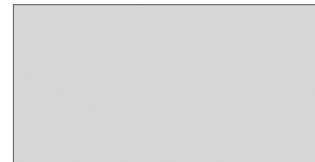

Gris



Haya

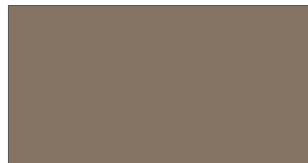

Chocolate

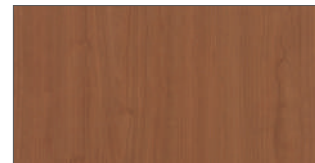

Cerezo

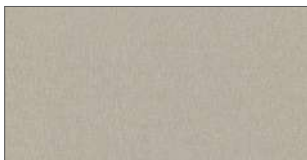

Lino Habana Textil



Roble Renovales



Azul



No cumplen norma EN 81.20



2.3 Acabados de cabina

Suelos

Goma antideslizante 4,5 kg / m²



Beige



Roble



Azul acero



Arena



Gris



Gris cemento



Negro

Piedra artificial 49 kg / m²



Gris Expo



Blanco Norte

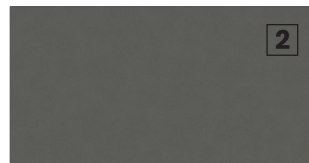

Cemento Spa



Negro Stellar



Royal Reef



Ethereal Glow



Rougui

2 Tarifa Tipo 2

3 Tarifa Tipo 3

Granito natural 56 kg / m²



Gris Perla



Rosa Porriño



Blanco Cristal



Blanco Trevi



Gris Quintana



Negro Intenso



Negro Sudáfrica



Andromeda



Azul Labrador oscuro



Guyana



Warwick Rubi

2 Tarifa Tipo 2

3 Tarifa Tipo 3

4 Tarifa Tipo 4

Suelos metálicos



Aluminio Damero 6 Kg/m²

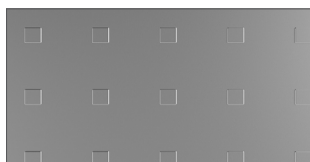

Acero Inox. 12 Kg/m²



Chapa lagrimada 36 Kg/m²

Techos

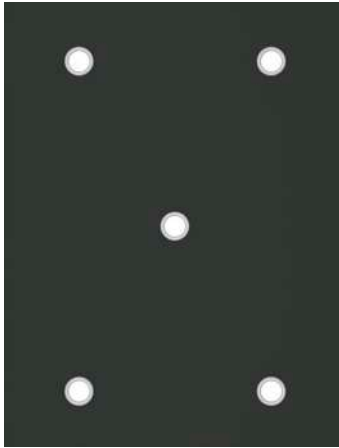

LED spots

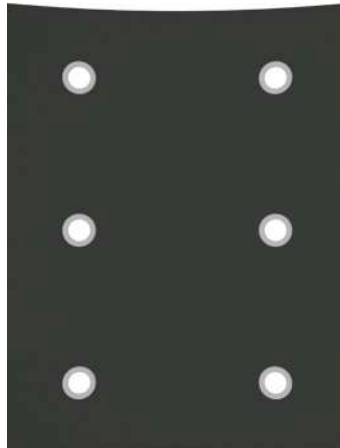

LED spots Curvo

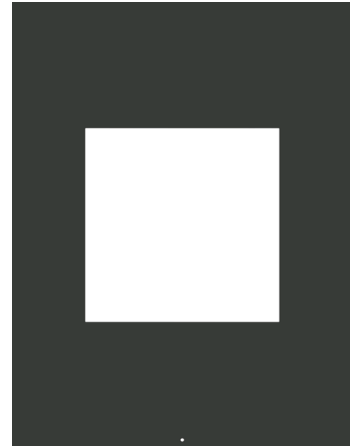

Panel LED

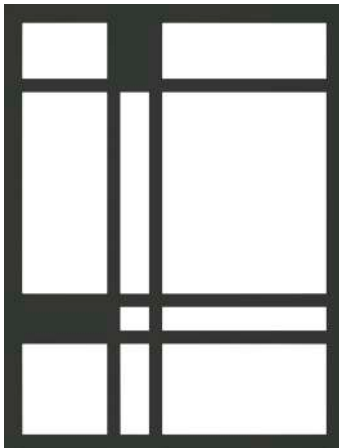

Mondrian

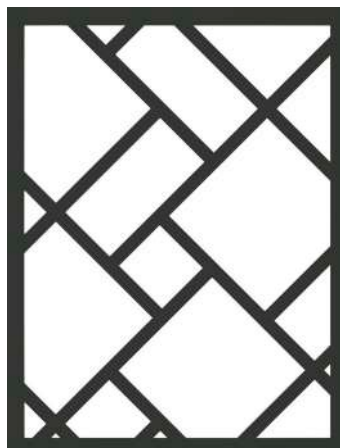

Arte

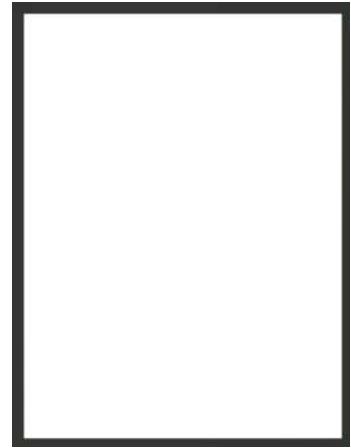

Marco

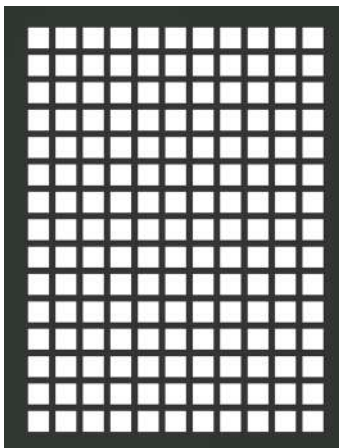

Mosaic



Cristal matizado

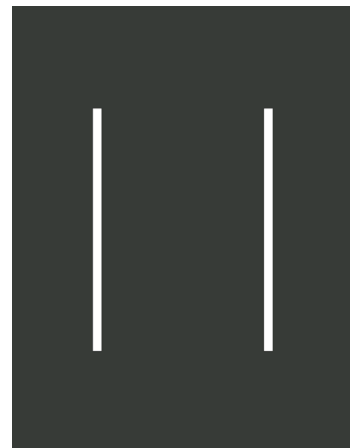

Barras LED

► Todos los techos se pueden seleccionar en color blanco, negro y acero inoxidable.

Iluminación indirecta



Iluminación en zócalo



Iluminación en paños



Iluminación en botonera



Iluminación en techo

Espejos



Espejo 1/2

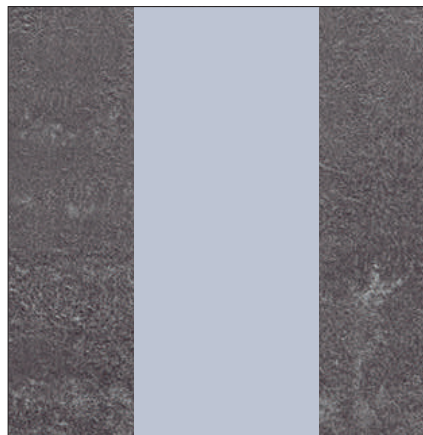

Espejo Lama

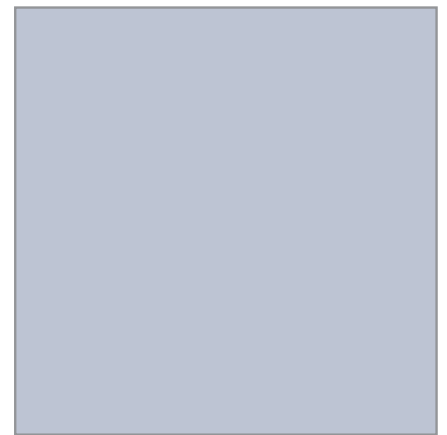

Espejo Entero

Pasamanos

NORMA EN 81-20

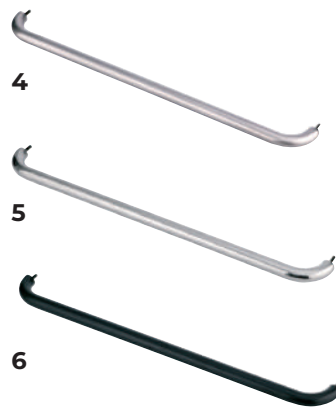
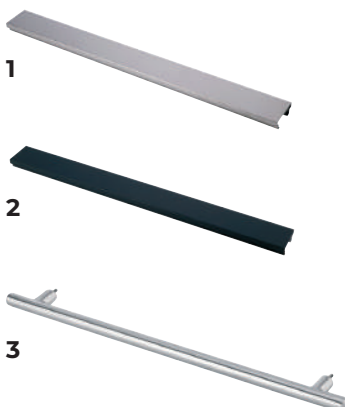

1. Rectangular inox.
2. Rectangular skinplate.
3. Tubular recto inox pulido.
4. Tubular curvo inox satinado.
5. Tubular curvo inox pulido.
6. Tubular curvo pintado en negro.

Puertas automáticas



Imprimación Acero Inox.



Gran mirilla



Bus cristal + aluminio



Cristal total Inox

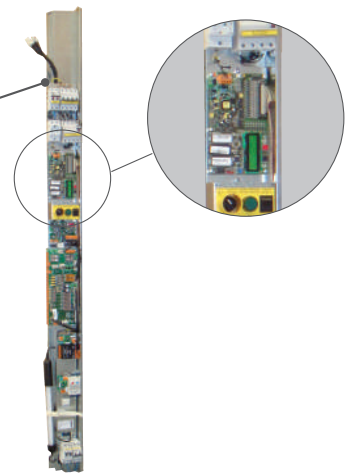

Cuadro de maniobra en marco puerta.

► Disponible en Carlos Silva, Elec Megom, Sprinte y NEW LIFT.



Puertas semiautomáticas



Mirilla



Gran mirilla

Acabados puertas

► Epoxi Gofrado

ESTÁNDARD

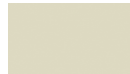

RAL 7032

OTROS



RAL 9016



RAL 1015



RAL 9006



RAL 7004



RAL 1018



RAL 1019



RAL 6021



RAL 1034



RAL 3020



RAL 5012



RAL 8023



RAL 7010



RAL 7012



RAL 3004



RAL 6005



RAL 5011



RAL 9005

► Acero inoxidable liso

ESTÁNDARD



AISI 441 2B/BA



AISI 304 2B



AISI 316 2B



AISI 441 2B



AISI 304 2B



AISI 304 2B



AISI 316 2B



AISI 316 4N

DECORATIVO



AISI 304 BA



AISI 304 BA



AISI 316 BA

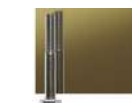

AISI 304 BA



AISI 304 BA



AISI 304 BA



AISI 304 BA

► Acero inoxidable con relieve



AISI 441 BA⁽¹⁾



AISI 304 BA



AISI 304 BA



AISI 316 BA⁽¹⁾



AISI 441 BA⁽¹⁾



AISI 304 BA



AISI 304 BA



AISI 304 BA



AISI 441 BA⁽¹⁾



AISI 304 BA



AISI 304 BA



AISI 316 BA⁽¹⁾

Disponible cualquier otro acabado de:



Botoneras cabina



luminación

Estándar
Longitud 1960 mm
Estándar solo para ascensores.
Para unifamiliar, irá sin display.

Cristal Glas

Tipo pasamanos (EN81.70)



- 1 Botonera columna estándar
- 2 Botonera de columna con iluminación
- 3 De superficie 920x220mm aluminio anodizado
- 4 Botonera de cristal

Botoneras rellano



De superficie en aluminio



De superficie en aluminio



Grabado sobre acero



Con placa transparente



De superficie en INOX



Con Display

Pulsadores



Bas 120



Bas 120 Black



RT42



US91-EN



US95-EN



US90 Jumbo



US95 Jumbo



B3 (Arkel)



B3 Black (Arkel)



V2-P (Arkel)

Indicadores



DE SUPERFICIE

Displays



TFT 2,8"
CARLOS SILVA



LCD10555
AR KEL



EM2LCD
MEGOM



LCDA
AR KEL



TFT 5,6"
CARLOS SILVA



MK_800
MEGOM



LIFTMEDIA
AR KEL



7"
CARLOS SILVA



10"
CARLOS SILVA



Your Partner
In Lift Solutions.



2.6

Estructuras

Las estructuras para ascensor y homelift, nos aportan normalización y flexibilidad, suprimiendo las barreras arquitectónicas y aportando soluciones de accesibilidad total.

ESTRUCTURAS

► Colores



RAL 9002



RAL 3004



RAL 1015



RAL 6005



RAL 7032



RAL 5003



RAL 7001



RAL 9005



RAL 8003



OXIRON

Ventajas

Los tiempos de obra y montaje se reducen en más de un 60% sobre una instalación con sistema constructivo tradicional, siendo un producto limpio, rápido y silencioso.

Absolutamente respetuoso con el medio ambiente, tanto en su proceso de montaje como en su desarrollo industrial.

Su facilidad de montaje, lo convierte en un producto altamente sencillo de trabajar, consiguiendo cumplir las más estrictas normas de seguridad.



Características

Solución técnica polivalente para cada edificio, adaptándole de forma eficaz a las diferentes tipologías y necesidades constructivas. Las series TC, están diseñadas para integrarse en total armonía en el edificio existente y su entorno.

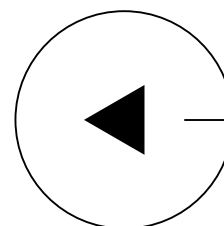



Opciones **y** accesorios



Techo (chapa o cristal)



Tejadillo en puerta (chapa o cristal)



Pasamanos



Ventilación



Tipos de cerramientos



Cristal butiral transparente



Cristal butiral matizado

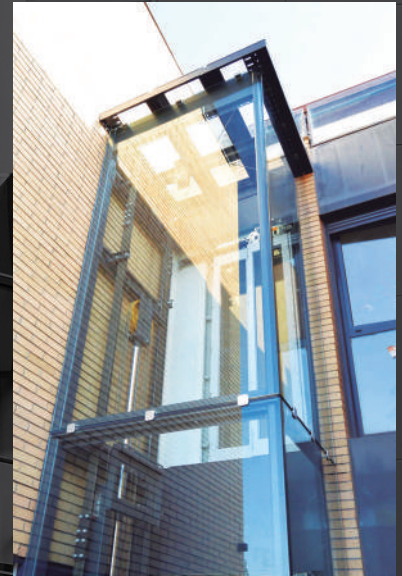

Cristal total



Chapa ciega



Chapa perforada



RALOE



Oficinas y delegaciones

CENTRAL / DELEGACIÓN VALENCIA

C/ Coeters, 27
46980 Paterna
+34 961 345 350
comercial@raloe.com

DELEGACIÓN MADRID

C/ Arboleda 18, Nave L
28031 Madrid
+34 913 013 720

DELEGACIÓN BARCELONA

C/ Montserrat Roig, 56
08908 L'Hospitalet
+34 932 643 910

RALOE EXPORT

+34 961 345 379
export@raloe.com

RALOE DEUTSCHLAND GmbH

Carl-Zeiss-Ring 14
85737 Ismaning
+49 (0) 89 306 44 765-0

RALOE UK LTD

Office F08, The Nucleus
Brunel Way, Dartford
Kent DA1 5GA
+44 (0) 759464 9122

DELEGACIÓN FRANCIA

Rue Alessandro Volta- 1er étage
Zone Industrielle de Marcerolles
26500 BOURG LES VALENCE
+33 615 587 392

WWW.RALOE.COM



