

# Your Partner In Lift Solutions.

Catálogo Accesibilidad.



# Catálogo **Accesibilidad**



|    |   |                       |                          |      |
|----|---|-----------------------|--------------------------|------|
| 01 | ▶ | <b>Unifamiliares</b>  |                          |      |
|    |   | 1.1                   | Voltec (Eléctrico)       | — 04 |
|    |   | 1.2                   | Armony (Hidráulico)      | — 08 |
|    |   | 1.3                   | Armony Lite (Hidráulico) | — 12 |
| 02 | ▶ |                       |                          |      |
|    |   | <b>Acabados</b>       |                          |      |
|    |   | 2.1                   | Modelos de cabinas       | — 16 |
|    |   | 2.2                   | Acabados de cabina       | — 22 |
|    |   | 2.3                   | Puertas                  | — 30 |
|    |   | 2.4                   | Botoneras y Displays     | — 33 |
|    |   | 2.5                   | Estructuras              | — 36 |
| 03 | ▶ |                       |                          |      |
|    |   | <b>Salvaescaleras</b> |                          |      |
|    |   | 3.1                   | Stylus                   | — 42 |
|    |   | 3.2                   | Stylus SX                | — 46 |



## 1.1

## Voltec

Elevador eléctrico conforme a la directiva de máquinas 2006/42 CE con infinidad de decoraciones de cabina y con un rango de carga hasta 500 kg.

### ► Aplicaciones

Residenciales

Eliminación de barreras arquitectónicas

Accesibilidad

## Ventajas

**Máxima Seguridad:** con freno en eje lento de la máquina para el control de movimientos incontrolados. Cables de tracción enfundados.

**Silencioso y gran confort** de viaje.

**Sin cuarto de máquinas:** Maniobra en el marco de la puerta y Variador en el hueco.

**Opción de armario integral en rellano.**

**Versatilidad decorativa:** Sin restricciones en las decoraciones de cabina.

**Monofásico:** Funciona en cualquier enchufe monofásico 220 V.

**Optimización del espacio:** Máxima optimización del espacio, similar a la de una solución hidráulica.

**Emergencia:** Dotado de un sistema de rescate que permite evacuar a los pasajeros aún sin suministro eléctrico.

**Sin aceite en el hueco.**

**Ideal para alto tráfico.**

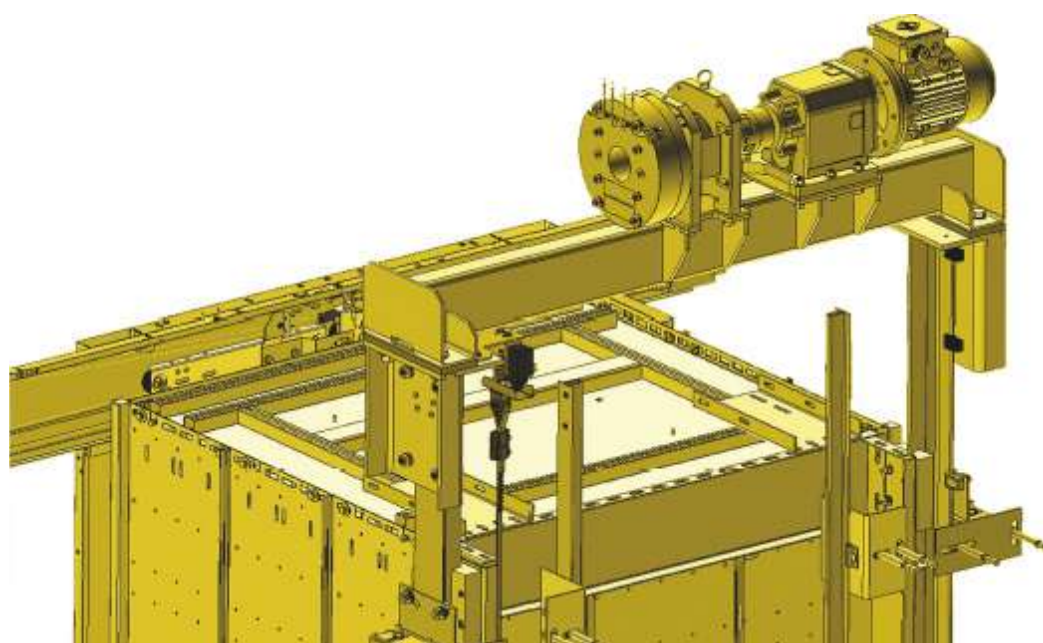
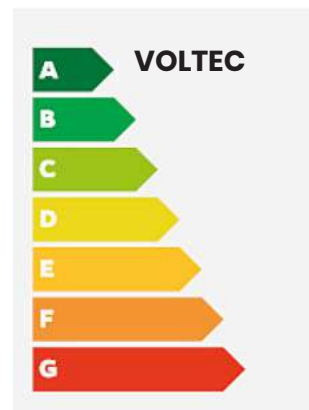



## Características Técnicas

|                          |   |     |
|--------------------------|---|-----|
| Carga Nominal (Kg)       | 300 - 500   |     |
| Velocidad Nominal (m/s)  | 0,15-0,30   |     |
| Suspensión               | 1:1   |     |
| Potencia Monofásica (KW) | 0,75  |     |
| Cuarto de Máquinas       | Sí / SCM con maniobra en el marco de la puerta                                    |     |
| Embarques                | 0 - 90° - 180° - 270°   |     |
| Recorrido (m)            | 15  |     |
| Fosos Mínimos (mm)       | Q ≤ 400 Kg  | 150 |
|                          | Q > 400 Kg  | 200 |
| Huida Mínima (mm)        | 2.650   |     |
| Tipo de Puerta           | Con o sin Puerta de Cabina<br>Puertas exteriores<br>Automáticas y Semiautomáticas |     |
| Tensión Alimentación     | Monofásica  |     |
| Modelos de Cabina        | Todas   |     |
| Ascensor Panorámico      | Sí  |     |
| Superficie de cabina     | Hasta 2m <sup>2</sup>   |     |



**SIN CUARTO  
DE MÁQUINAS**

Maniobra en el marco de la puerta y diseño de cabina.

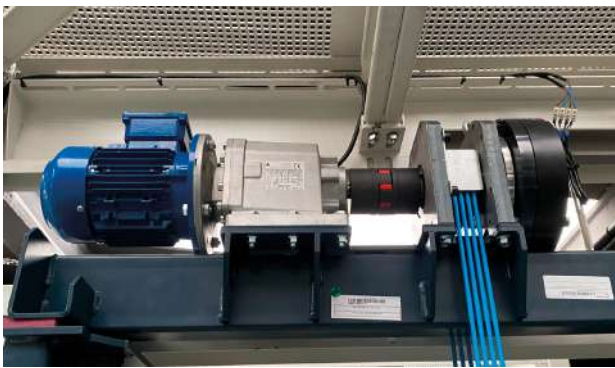
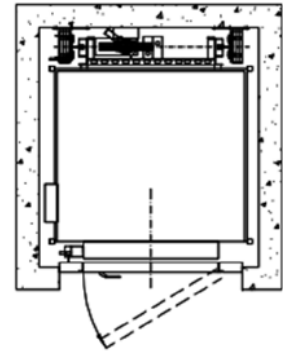
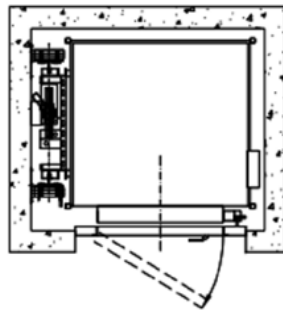
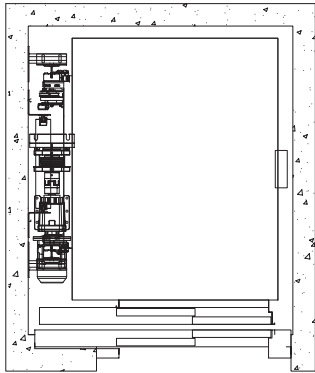
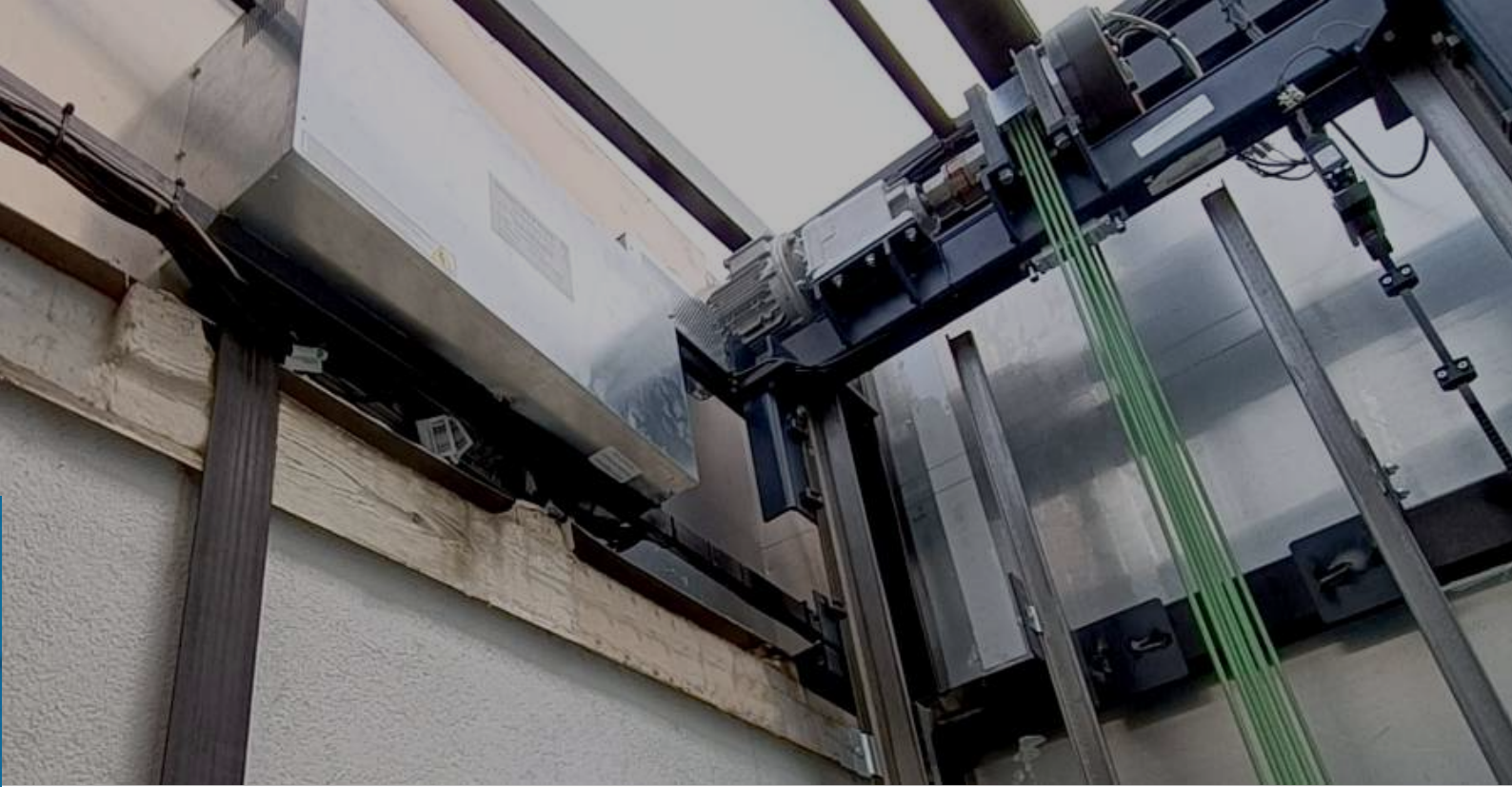

Reductor con cable enfundado.  
Freno en eje lento.

Variador en el hueco.  
Opción de armario integral en rellano.





## 1.2

## Armony

Armony es el unifamiliar más versátil con infinidad de decoraciones de cabina y con un rango de carga hasta 500 kg.

### ► Aplicaciones

**Residenciales**

**Eliminación de barreras arquitectónicas**

**Accesibilidad**



## Ventajas

### Máxima seguridad:

Hemos estudiado de forma exhaustiva su estructura para que garantice los niveles de seguridad de un ascensor: Sistemas de detección de paso, reapertura de puertas para evitar golpear al usuario y renivelación de la cabina.

### Versatilidad decorativa:

Catálogo de posibilidades de decoración muy amplio.

### Monofásico:

Funciona en cualquier enchufe monofásico 220 V.

### Optimización del espacio:

Aprovechamiento del hueco hasta un 80%.

### Emergencia:

Dotado de un sistema de rescate que permite evacuar a los pasajeros aun sin suministro eléctrico.

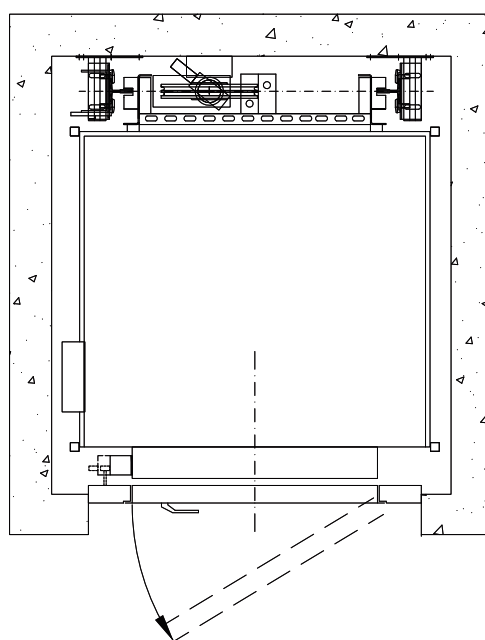
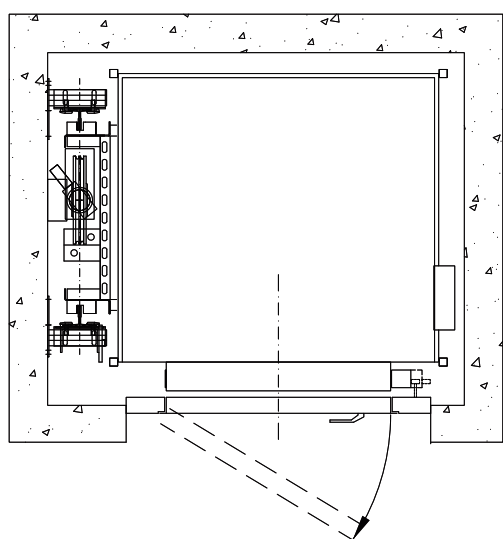



## Características Técnicas

Carga Nominal (Kg) 180 - 500

Velocidad Nominal (m/s) 0.15-0,30

Potencia Monofásica (KW) Desde 2,2

Cuarto de Máquinas Sí / Central en Armario

Embarques 0 - 90° - 180° - 270°

Recorrido (m) 15

Fosos Mínimos (mm) Q ≤ 400 Kg 135  
Q > 400 Kg 200

Huida Mínima (mm) 2.285 Sin Puerta en Cabina

Tipo de Puerta Con o sin Puerta de Cabina  
Puertas exteriores  
Automáticas y Semiautomáticas

Tensión Alimentación Monofásica\*

Modelos de Cabina Todas

Ascensor Panorámico Sí

Superficie de cabina Hasta 2m<sup>2</sup>

\*Posibilidad de tensión trifásica.

**Opción:**  
Con puerta en cabina.



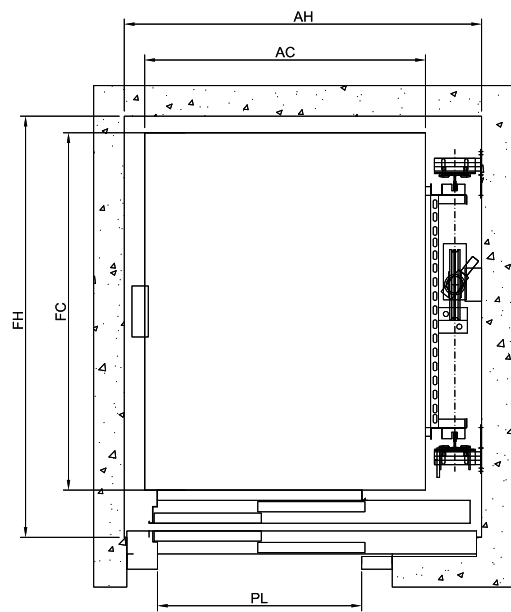
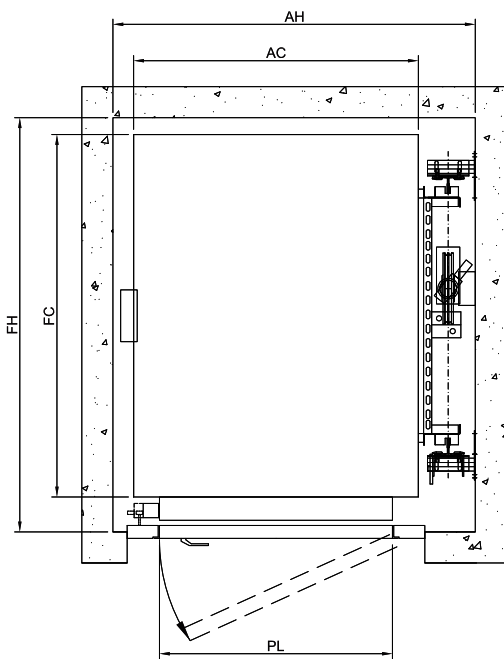

## Armarios prefabricados

Disponemos de un KIT premontado, que consiste en: conjunto central + armario + maniobra, todo ya ensamblado, precableado y probado desde fábrica. Facilita la puesta en marcha (Plug and Play).



## 1.3 Armony Lite

Armony Lite es el unifamiliar hidráulico con la mejor relación calidad-precio del mercado.

**Decoraciones cabina:**  
Modelos OPTIMA y DINAMIC.

**Opción:**  
Con puerta en cabina.



**Opción más competitiva para un unifamiliar.**

**Conjunto compacto chasis + cabina con gran robustez.**

**Fácil Montaje desde el interior de la cabina.**





► **Modelos de cabina Armony Lite**



**Dynamic**



**Optima**



## Características Técnicas

|                          |  |
|--------------------------|--|
| Carga Nominal (Kg)       | 180 - 385  |
| Velocidad Nominal (m/s)  | 0,15   |
| Potencia Monofásica (KW) | Desde 2,2  |
| Cuarto de Máquinas       | Sí / Central en Armario  |
| Embarques                | 0 - 90°- 180° - 270°   |
| Recorrido (m)            | 15   |
| Foso Mínimo (mm)         | 100  |
| Huida Mínima (mm)        | 2.450  |
| Tipo de Puerta           | Con o sin Puerta de Cabina<br>Puerta exteriores<br>Automáticas y Semiautomáticas |
| Tensión Alimentación     | Monofásica*  |
| Modelos de Cabina        | Dinamic / Optima   |
| Ascensor Panorámico      | No   |

\*Posibilidad de tensión trifásica.





Your Partner  
**In Lift Solutions.**





## 2.1 Modelos de cabina

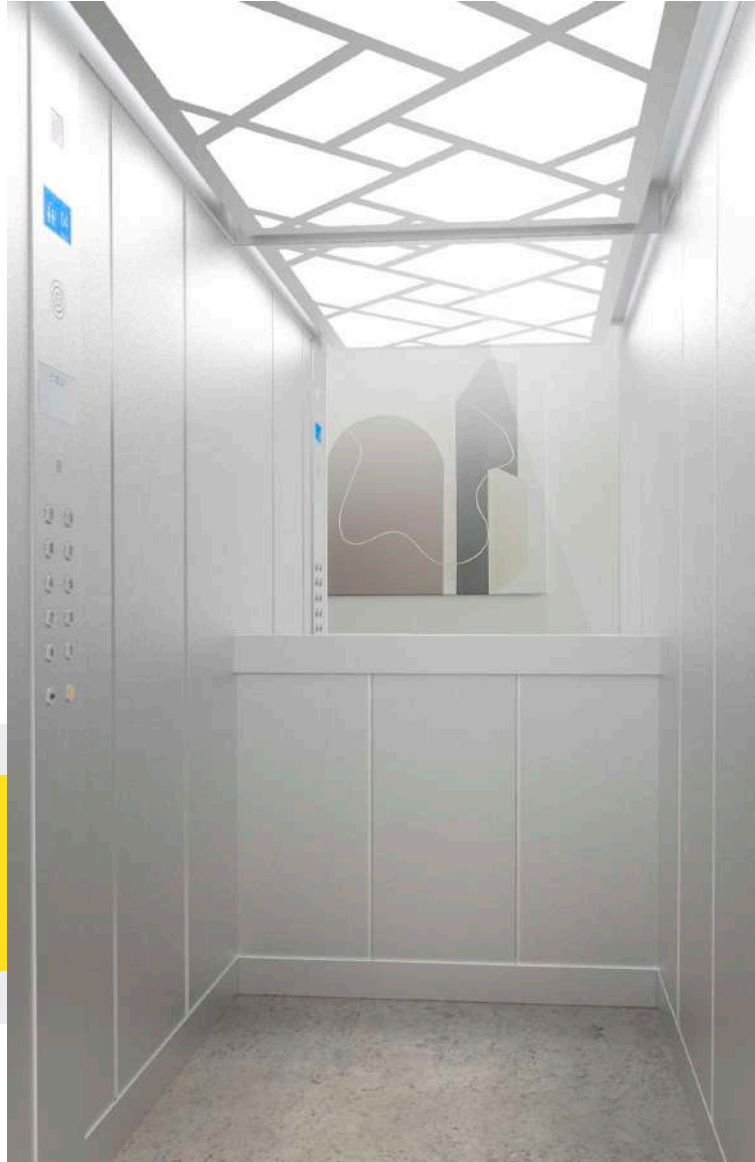

101

**Paños**

Acero Inox. Checks



**Unión**

Lama sin separación



**Suelo**

Granito Natural Warwick





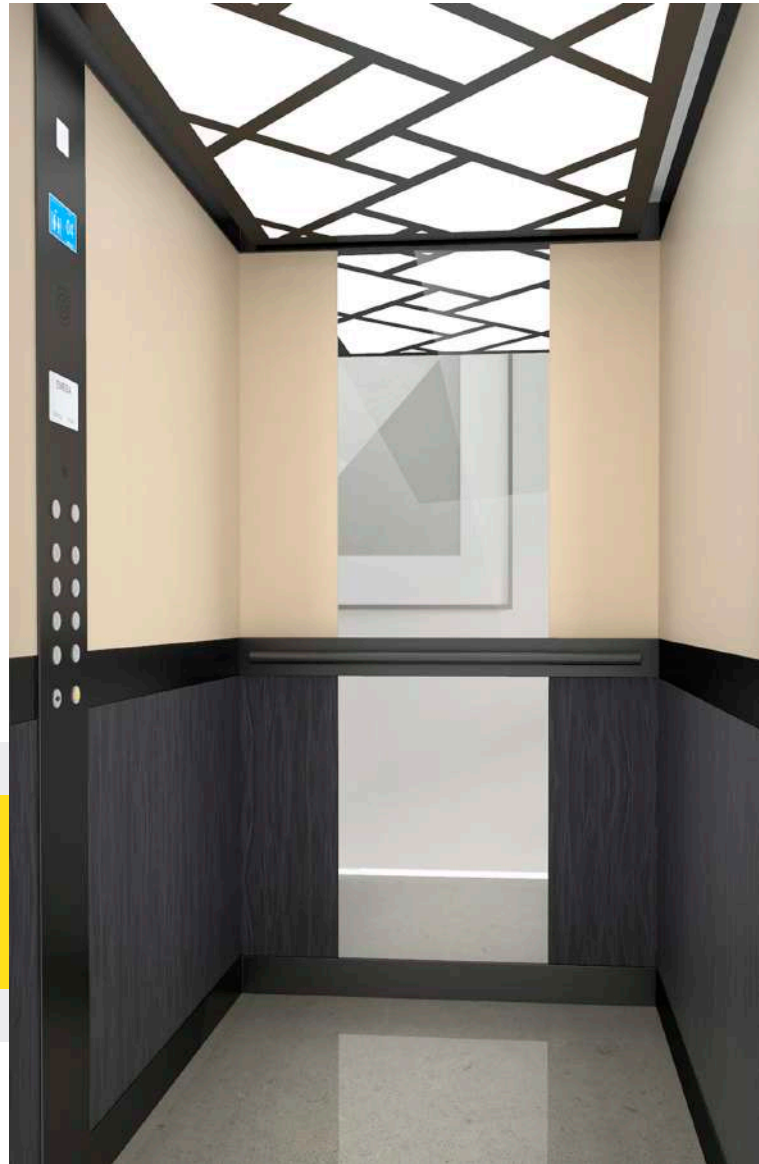

## L03

### Paños

F6307 Burnt Strand



F2833 Arena Pétreo

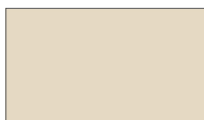

Laminado

### Unión

Paño liso

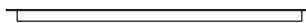

### Suelo

Piedra artificial Royal Reef



\* M03 también disponible en Melamina



## 2.1

# Modelos de cabina



## L04

### Paños

F7327 Gris Popular



F8830 Elemental Concrete



Laminado

### Unión

Paño liso



### Suelo

Negro Stellar



### Iluminación paño

Pareja tiras LED verticales



# S01

**Paños**

Skinplate Acero Inox



**Unión**

Lama sin separación



**Suelo**

Antideslizante negro





## 2.1

## Modelos de cabina



### CH01

#### Paños

Marfil Claro RAL 1015

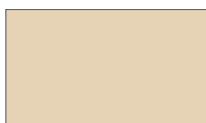

Chapa pintada

#### Unión

Lama sin separación



#### Suelo

Rosa Porriño





# Quartz

**Paños**

Rojo Terracota RAL 8815



Vidrio lacado

**Unión**

Paño liso



**Suelo**

Negro Inteso





## 2.2 Acabados de cabina

### Paños

#### Skinplates



Blanco

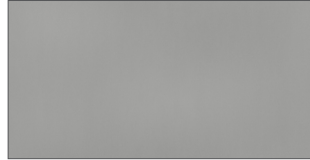

Simil Inox.

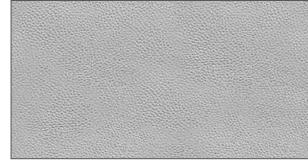

Gris



Acero Inox.

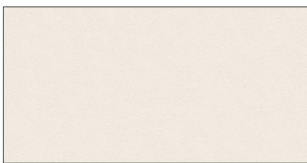

Crema

#### Chapa pintada



Blanco RAL 9016



Beige RAL 1019



Negro RAL 9005



Marfil Claro RAL 1015



Gris metalizado RAL 9006



Gris claro perlado RAL 9022

2

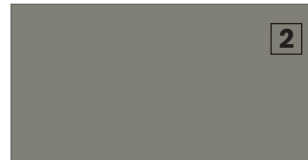

Gris Hormigón RAL 7023

2



Violeta Pastel RAL 4009

2

2 Tarifa Tipo 2

\*Cualquier otro RAL disponible bajo pedido

#### Aceros inoxidables

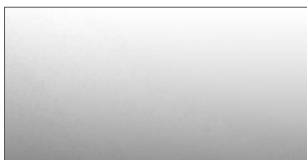

Satinado

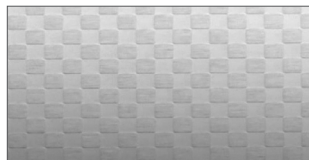

Checks

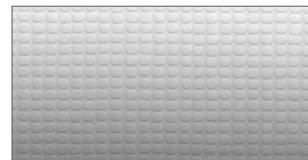

Canvas

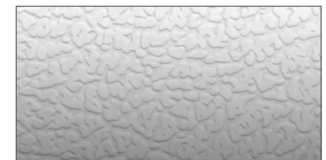

Cuero

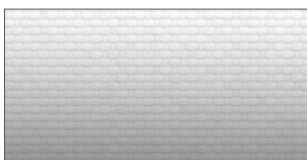

Linen



Pulido

Disponibles cualquier otro acabado de:





## Paños

### Vidrio lacado



Gris metal RAL 9006



Marrón Claro RAL 1236



Verde RAL 8615



Aluminio RAL 9007



Blanco puro RAL 9003

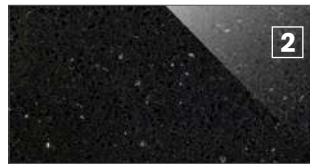

Negro Estelar RAL 0337



B. Perla RAL 1013 (mate o brillo)



Bronce

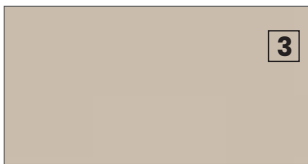

Marrón Claro RAL 1236 (Mate)



Rojo Terracota RAL 8815



Verde Pistacho RAL 1164

**2** Tarifa Tipo 2

**3** Tarifa Tipo 3

### Vidrio lacado bajo pedido



RAL 1586



RAL 8017

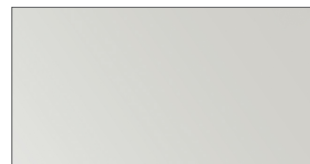

PLATA



RAL 5002



RAL 2001



RAL 9005





## 2.2 Acabados de cabina

### Laminados

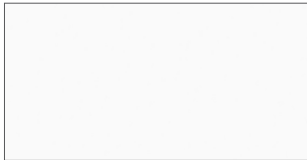

F2274 Blanco Francia



F1139 Cerezo



F7884 Azul China



F7837 Grafito

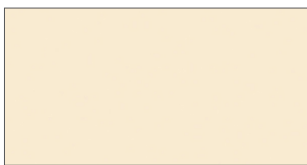

F2273 Seringa



F1062 Roble

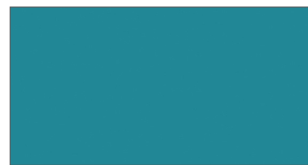

F2478 Turquesa



F8833 Elemental Graphite

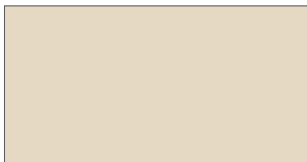

F2833 Arena pétreo



F5873 SET Ventura Oak



F1997 Oceano



F8832 Elemental Corten



F8841 White Ash

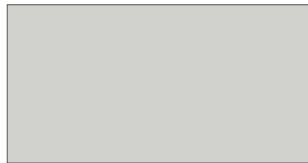

F7927 Gris Popular



F8849 Natural Teak

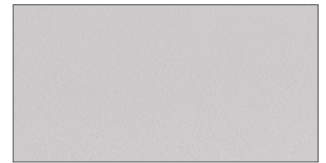

F0193 Xenon



F0190 Haya finlandesa



F8830 Elemental Concrete



F8848 Blackened Legno

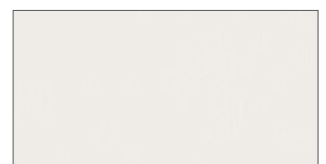

F7923 Surf



F3091 Blanco Polar Brillo



F6307 Burnt Strand

**3** Tarifa Tipo 3

\* Resto de formicas disponibles en <https://www.formica.com/es-es>

Los colores mostrados pueden variar respecto a los reales, en función de la configuración del monitor o de las condiciones de impresión.





## Paños

### Melamina

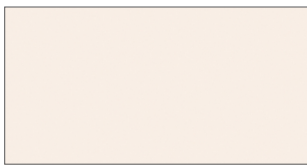

Crema

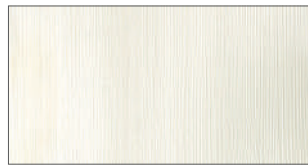

Pino Cervino

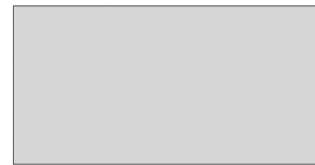

Gris

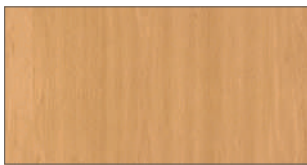

Haya



Chocolate

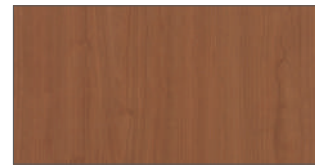

Cerezo

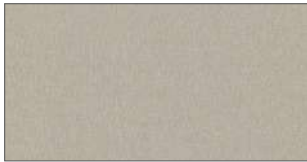

Lino Habana Textil

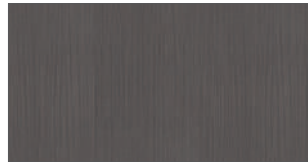

Roble Renovales

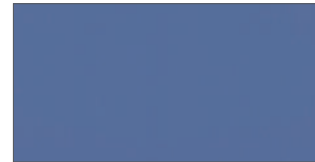

Azul



No cumplen norma EN 81.20



## 2.2 Acabados de cabina

### Suelos

#### Goma antideslizante 4,5 kg / m<sup>2</sup>



Beige



Roble



Azul acero



Arena



Gris



Gris cemento



Negro

#### Piedra artificial 49 kg / m<sup>2</sup>



Gris Expo



Blanco Norte

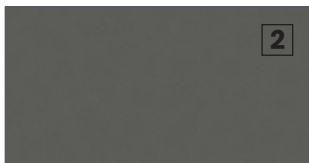

Cemento Spa



Negro Stellar



Royal Reef



Ethereal Glow



Rougui

**2** Tarifa Tipo 2

**3** Tarifa Tipo 3

**Granito natural 56 kg / m<sup>2</sup>**



Gris Perla



Rosa Porriño



Blanco Cristal



Blanco Trevi



Gris Quintana



Negro Intenso



Negro Sudáfrica



Andromeda



Azul Labrador oscuro



Guyana



Warwick Rubi

2 Tarifa Tipo 2

3 Tarifa Tipo 3

4 Tarifa Tipo 4

**Suelos metálicos**



Aluminio Damero 6 Kg/m<sup>2</sup>



Acero Inox. 12 Kg/m<sup>2</sup>



Chapa lagrimada 36 Kg/m<sup>2</sup>

### Techos

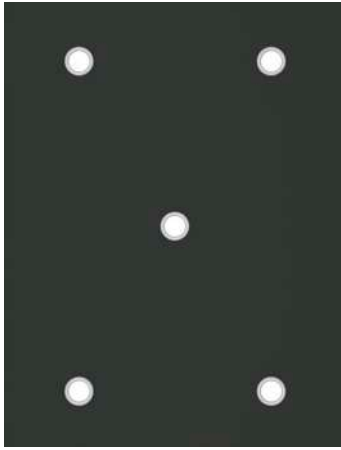

LED spots

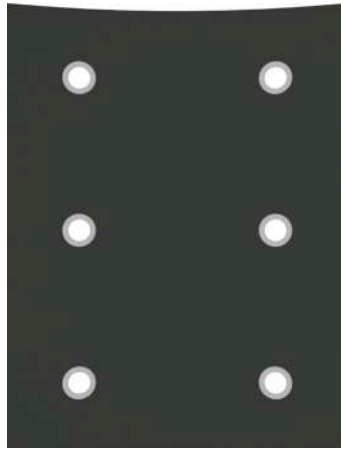

LED spots Curvo

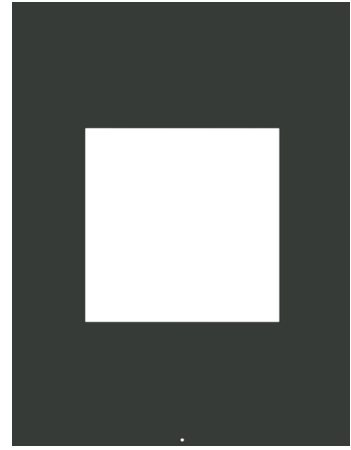

Panel LED

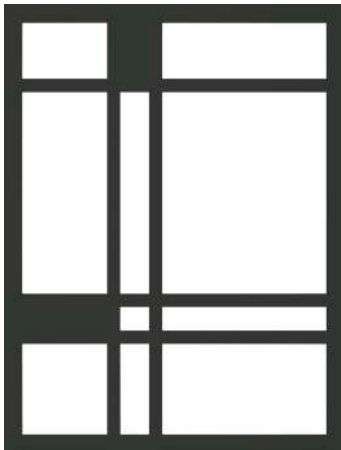

Mondrian

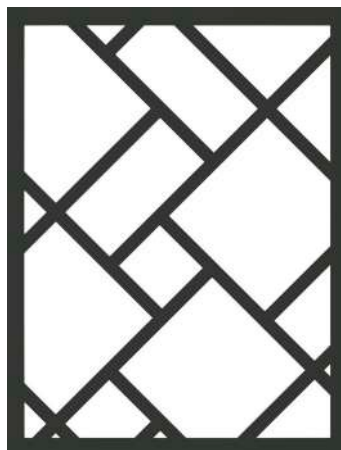

Arte

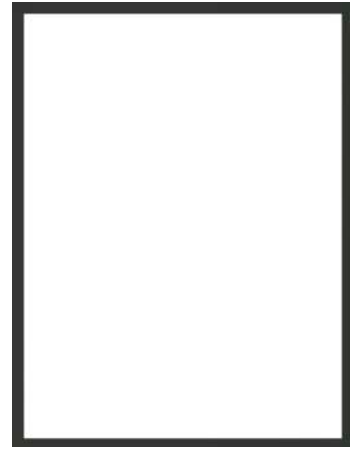

Marco

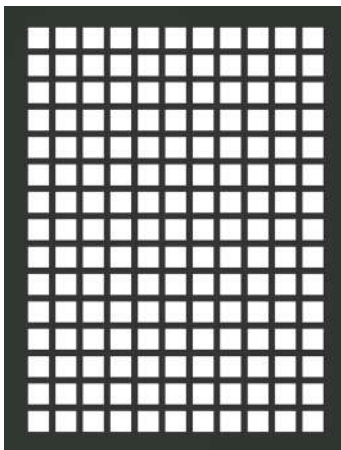

Mosaic



Cristal matizado

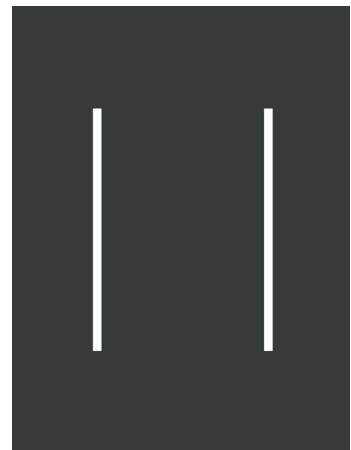

Barras LED



Todos los techos se pueden seleccionar en color blanco, negro y acero inoxidable.

## Iluminación indirecta



Iluminación en zócalo



Iluminación en paños



Iluminación en botonera



Iluminación en techo

## Espejos



Espejo 1/2

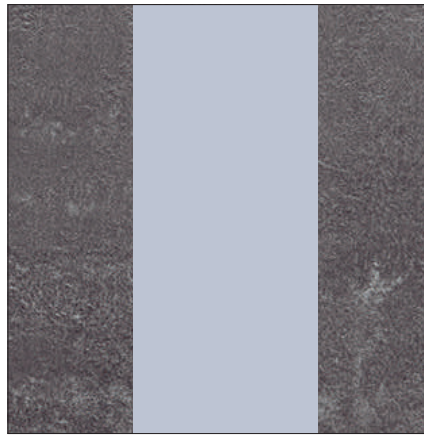

Espejo Lama

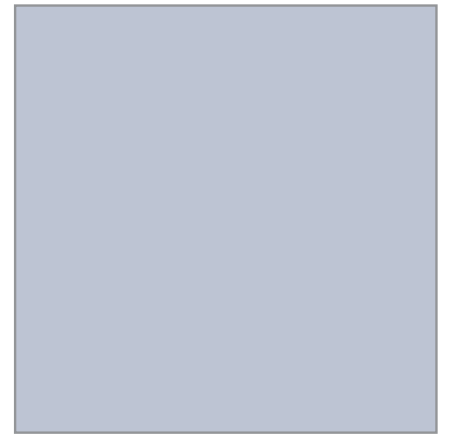

Espejo Entero

## Pasamanos

NORMA EN 81-20

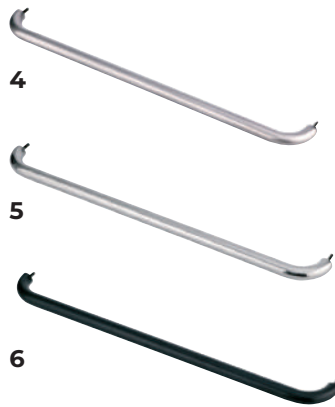
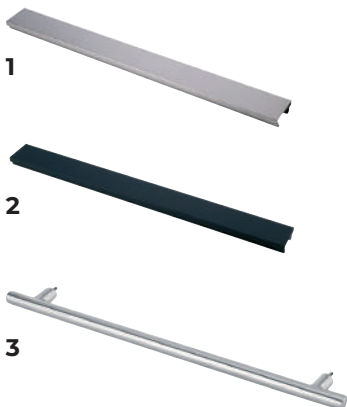

1. Rectangular inox.
2. Rectangular skinplate.
3. Tubular recto inox pulido.
4. Tubular curvo inox satinado.
5. Tubular curvo inox pulido.
6. Tubular curvo pintado en negro.

## Puertas automáticas



Imprimación Acero Inox.



Gran mirilla



Bus cristal + aluminio



Cristal total Inox



RALOE

## Puertas semiautomáticas

---



Mirilla



Gran mirilla

Acabados puertas

► Epoxi Gofrado

ESTÁNDAR



RAL 7032

OTROS



RAL 9016

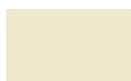

RAL 1015



RAL 9006



RAL 7004



RAL 1018



RAL 1019



RAL 6021



RAL 1034



RAL 3020



RAL 5012



RAL 9005



RAL 7010



RAL 7012



RAL 3004



RAL 6005



RAL 5011

► Acero inoxidable liso

ESTÁNDAR



AISI 441 2B/BA



AISI 304 2B



AISI 316 2B



AISI 441 2B



AISI 304 2B



AISI 304 2B



AISI 316 2B



AISI 316 4N

DECORATIVO



AISI 304 BA



AISI 304 BA



AISI 316 BA



AISI 304 BA



AISI 304 BA



AISI 304 BA



AISI 304 BA

► Acero inoxidable con relieve



AISI 441 BA<sup>(1)</sup>



AISI 304 BA



AISI 304 BA



AISI 316 BA<sup>(1)</sup>



AISI 441 BA<sup>(1)</sup>



AISI 304 BA



AISI 304 BA



AISI 304 BA



AISI 441 BA<sup>(1)</sup>



AISI 304 BA



AISI 304 BA



AISI 316 BA<sup>(1)</sup>

Disponible cualquier otro acabado de:





## Botoneras cabina



luminación

Estándar  
Longitud 1960 mm  
Estándar solo para ascensores.  
Para unifamiliar, irá sin display.

Cristal Glas

### Tipo pasamanos (EN81.70)



- 1 Botonera columna estándar
- 2 Botonera de columna con iluminación
- 3 De superficie 920x220mm aluminio anodizado
- 4 Botonera de cristal

## Botoneras rellano



De superficie en aluminio



De superficie en aluminio



Grabado sobre acero



Con placa transparente



De superficie en INOX



Con Display

## Pulsadores



Bas 120



Bas 120 Black



RT42



US91-EN



US95-EN



US90 Jumbo



US95 Jumbo



B3 (Arkel)



B3 Black (Arkel)



V2-P (Arkel)

## Indicadores



DE SUPERFICIE



FLECHAS DE SENTIDO



RETRO

Displays



TFT 2,8"  
CARLOS SILVA



LCD10555  
ARKEK



EM2LCD  
MEGOM



LCDA  
ARKEK



TFT 5,6"  
CARLOS SILVA



MK\_800  
MEGOM



LIFTMEDIA  
ARKEK



7"  
CARLOS SILVA



10"  
CARLOS SILVA



## 2.5 Estructuras

Las estructuras para ascensor y homelift, nos aportan normalización y flexibilidad, suprimiendo las barreras arquitectónicas y aportando soluciones de accesibilidad total.

### ESTRUCTURAS

#### ► Colores



RAL 9002



RAL 3004



RAL 1015



RAL 6005



RAL 7032



RAL 5003



RAL 7001



RAL 9005



RAL 8003



OXIRON

## Ventajas

Los tiempos de obra y montaje se reducen en más de un 60% sobre una instalación con sistema constructivo tradicional, siendo un producto limpio, rápido y silencioso.

Absolutamente respetuoso con el medio ambiente, tanto en su proceso de montaje como en su desarrollo industrial.

Su facilidad de montaje lo convierte en un producto altamente sencillo de trabajar, consiguiendo cumplir las más estrictas normas de seguridad.



## Características

Solución técnica polivalente para cada edificio, adaptándose de forma eficaz a las diferentes tipologías y necesidades constructivas. Las series TC, están diseñadas para integrarse en total armonía en el edificio existente y su entorno.

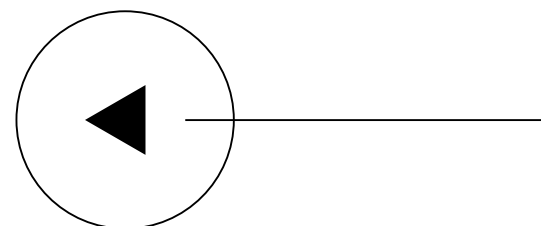



## Opciones **y** accesorios



Techo (chapa o cristal)



Tejadillo en puerta (chapa o cristal)



Pasamanos



Ventilación



# Tipos de cerramientos

---



Cristal butiral transparente

---



Cristal butiral matizado

---



Cristal total

---



Chapa ciega

---



Chapa perforada

---

RALOE



Tu partner experto  
**y de confianza**



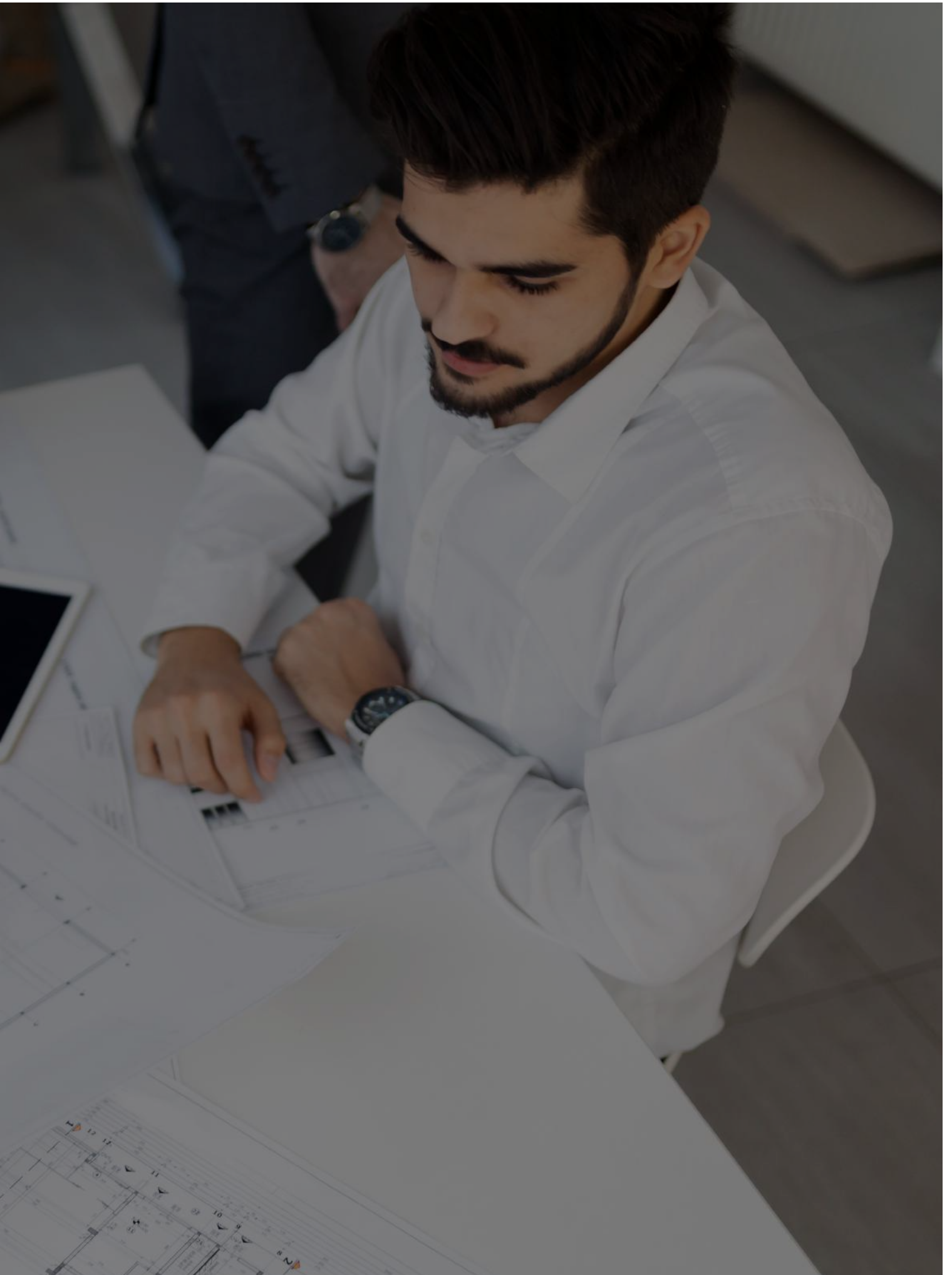



Stylus es el salvaescaleras vertical de gran confort y fácil instalación.

## Salvaescaleras STYLUS

Salvaescaleras STYLUS es un producto **enfocado a salvar las barreras arquitectónicas que impiden del acceso a edificios**, o una completa movilidad en las viviendas, a aquellas personas con movilidad reducida que necesitan silla de ruedas para su desplazamiento.

**Se trata del Elevador vertical de uso para personas con movilidad reducida, Stylus.** Diseño compacto, robusto y ergonómico. Acorde con la Directiva de Máquinas Europea 2006/42/CE o la norma EN81.41

### ► Aplicaciones

Residenciales

Eliminación de barreras arquitectónicas

Accesibilidad

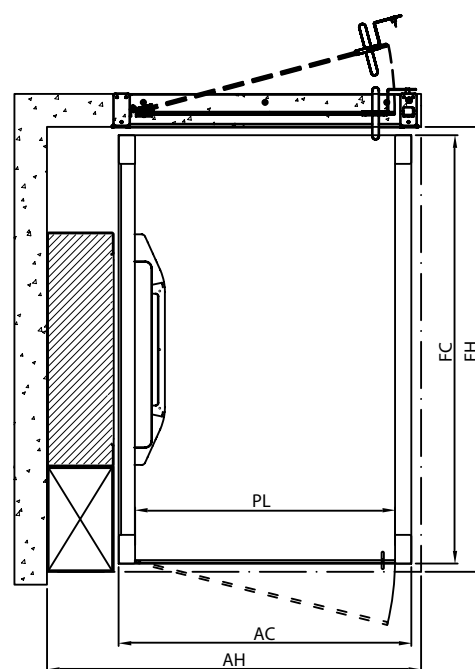

## Características Técnicas

|                                |              |
|--------------------------------|--------------|
| <b>Carga Nominal (Kg)</b>      | Hasta 500    |
| <b>Velocidad Nominal (m/s)</b> | 0,15*        |
| <b>Recorrido (m)</b>           | Hasta 3 o 12 |
| <b>Potencia Motor (CV)</b>     | 2            |
| <b>Foso Mínimo (mm)</b>        | 130          |
| <b>Alimentación</b>            | Monofásica   |

\*Con regulación VVF en subida y válvula hidráulica de 2 velocidades en bajada.



## Características

**Central hidráulica** con control de subida mediante variador VVF y dos velocidades de bajada. Renivelación automática.

**Columna** realizada mediante perfiles metálicos galvanizados cada 500 mm, guías específicas para elevación que garantiza el guiado del chasis y cumplimiento de flexiones según norma EN81-20.

**Tracción:** Suspensión 1:1, mediante cilindro hidráulico de simple efecto (hasta recorridos de 1,5 m y telescópico de 2 etapas, hasta 3,0 m de recorrido).

Suspensión 2:1 mediante cilindro hidráulico de simple efecto hasta 12 m de recorrido. Con hueco cerrado y verificación unitaria.

**Chasis** realizado con perfiles metálicos galvanizados y palasen acero cincado.

**Botonera de cabina** integrada en pasamanos. Pulsadores con braille e indicadores acústicos para sobrecarga y emergencia. Para dos paradas, Joystick en vez de pulsador.

**Puertas:** Bastidor de puertas autoportante mediante perfiles tubulares y vidrios templados. Cerradura eléctrica de seguridad con desenclavamiento mediante llave triangular. Altura 1200 mm o 2000 mm.

**Maniobra** mediante autómatas programables y configurables. Dos líneas para visión del estado del elevador y programación sencilla. Pre montada y sistema de pulsación constante.

**Central hidráulica** con motor alimentado con tensión de entrada 220 Vac monofásica, bomba de husillo ultra silenciosa y válvula mecánica de altas prestaciones.

**Número máximo de paradas 4.**

**Medidas estándar:** 900x1300mm (Útiles 800x1300 mm interior).



## Sistemas de Seguridad

**Sistema de rescate automático** mediante baterías. Dispositivo anti-aplastamiento bajo la base en funcionamiento en bajada.

**Válvula paracaídas** certificada EN-81.20 (paracaídas en caso de rotura de cables para suspensión 2:1).

**Pesacargas mecánico.**

**Accionamiento mediante pulsación constante.**

**Rescate:** Mediante UPS 220 Vac, funcionamiento únicamente en descenso en caso de corte de fluido eléctrico.

**Cerradura eléctrica de seguridad** con desenclavamiento mediante llave triangular.

**Suelo cabina antideslizante.**

**Posibilidad de colocar Fuelle.**



En Raloe disponemos de un producto **enfocado a salvar las barreras arquitectónicas** que impiden el acceso a personas con movilidad reducida en recorridos cortos.

**Diseño compacto, robusto y ergonómico.**  
Acorde con la Directiva de Máquinas Europea 2006/42/CE.

## ► Aplicaciones

Residenciales  
Eliminación de barreras arquitectónicas  
Accesibilidad



## Características Técnicas

|                                |   |
|--------------------------------|---|
| <b>Carga Nominal (Kg)</b>      | Hasta 385 (según dimensiones)           |
| <b>Velocidad Nominal (m/s)</b> | 0,15                                    |
| <b>Recorrido (m)</b>           | Hasta 1                                 |
| <b>Foso mínimo (mm)</b>        | 130 sin rampa.                          |
| <b>Alimentación</b>            | Monofásica 220 Vac. Hasta 1,5 KW, 12 A. |



## Características

**Bastidor** realizado mediante perfiles metálicos tubulares y chapa decapada. Guiado de la plataforma mediante piezas de acero mecanizadas.

**Semicabina con cerramiento lateral** a 1,2 m o plataforma con rodapiés inferiores anticaídas y guiado mediante tubos curvados de acero.

**Acceso a la plataforma mediante rampa** mecánica, eléctrica o sin rampa (con foso de 130 mm).

**Cerradura eléctrica** de seguridad con desenclavamiento mediante llave triangular.

**Pulsador integrado** en puertas, evitando instalaciones exteriores. Cerrojo ajustable para aseguramiento del cierre. Amortiguador de cierre mediante sinentblock cilíndrico.

**Botonera de cabina integrada** en el pasamanos. Joystick, led de estado de funcionamiento y luz de sobrecarga.

**Armario eléctrico y central.** Maniobra mediante autómatas programables y configurables. 2 líneas para visión del estado del elevador y programación sencilla.

**Tracción mediante 2 cilindros** hidráulicos de simple efecto y central con bomba de husillo silenciosa y válvula paracaídas regulado y certificado EN 81-20 & 50.

### Medidas:

- 900 x 1540 mm (800 x 1540 mm interior).
- 1000 x 1540 mm (900 x 1540 mm interior).
- 1200 x 1540 mm (1100 x 1540 mm interior).



**Válvula paracaídas** regulado en fábrica según EN 81.20.

**Cerraduras eléctricas** de seguridad con control de presencia y cerrojo y accionamiento de desenclavamiento con llave triangular.

**Pesa cargas hidráulico.**

**Pulsadores** tipo presión permanente con baille y luminoso.

**STOP de emergencia.**

**Fuelle de protección perimetral** con bordes sensibles de seguridad.

**Rescate mediante batería,** funcionamiento únicamente en descenso en caso de corte de fluido eléctrico.

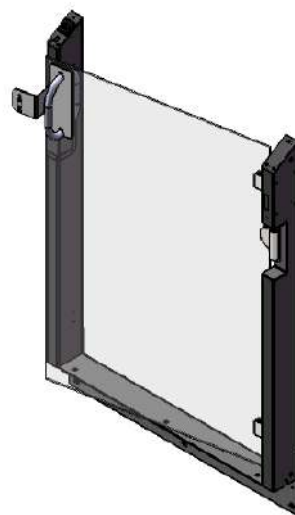
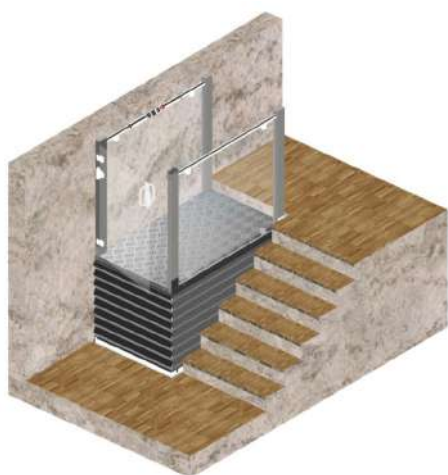

## Opciones

**Botonera de rellano:** Llavín.

**Pulsador:** (estándar)  
Llavín inalámbrico.

**Pulsador inalámbrico.**

**Tipo de acceso:** 90° – 180° – 270°  
Teléfono en cabina.  
Fotocélulas en pasamanos.  
Fotocélulas en embarques.

**Puertas:** Semipuerta cabina altura 1200 mm cristal total.  
Puerta rellano altura 2000 mm cristal total.

**Rampa de acceso batiente:**  
(obligatoria si el foso es menor a 130 mm).

**Cuadro de maniobra intemperie.**

**Cierrapuertas mecánico.**

**Puertas automáticas.**

**Acabados:** en cualquier RAL o acero inoxidable  
(estándar RAL 9010 + RAL 9006).  
Opción intemperie (inox 304 y 316).



RALOE



## Oficinas y delegaciones

### CENTRAL / DELEGACIÓN VALENCIA

C/ Coeters, 27  
46980 Paterna  
+34 961 345 350  
comercial@raloe.com

### DELEGACIÓN MADRID

C/ Arboleda 18, Nave L  
28031 Madrid  
+34 913 013 720

### DELEGACIÓN BARCELONA

C/ Montserrat Roig, 56  
08908 L'Hospitalet  
+34 932 643 910

### RALOE EXPORT

+34 961 345 379  
export@raloe.com

### RALOE DEUTSCHLAND GmbH

Carl-Zeiss-Ring 14  
85737 Ismaning  
+49 (0) 89 306 44 765-0

### RALOE UK LTD

Office F08, The Nucleus,  
Brunel Way, Dartford  
Kent DA1 5GA  
+44 (0) 759464 9122

### DELEGACIÓN FRANCIA

Rue Alessandro Volta- 1er étage  
Zone Industrielle de Marcerolles  
26500 BOURG LES VALENCE  
+33 615 587 392

A photograph of three business professionals (two women and one man) standing in an elevator. They are all dressed in business casual attire. The woman in the center is holding a tablet and looking at it with a smile. The woman on the left is also looking at the tablet. The man on the right is looking towards the women. The elevator has glass walls and a metal handrail. The overall tone is professional and collaborative.

Your Partner  
**In Lift Solutions.**



